

The Radio Dealer

Published Monthly by
The Radio Dealer Co.,
1133 Broadway, New
York, N. Y.

VOL. I No. 5

For The Radio Retailer

AUGUST, 1922

Application pending for
entry as second class
matter at the Post Office
at New York, N. Y.

ONE DOLLAR THE YEAR

STANDARD

Trade-Marked

Nationally
Advertised

RADIO MERCHANDISE

Will Help You Establish a Substantial Business!

Radio business will be brisk this fall and Christmas, but the radio buyers will carefully pick and choose. They will read more advertising and insist upon products of recognized merit.

The services of the Wholesale Radio Equipment Co. will be of inestimable help to you in holding this trade and firmly establishing your business. You can draw upon our never-exhausted stocks of radio products of 16 or more important nationally

known manufacturers and always depend upon delivery to the promised minute. Advantageous discounts. Drop us a line now while it is fresh in your mind. Let us help you plan your business for the next six months.



Get Your Share of the Fall and Christmas Trade **NOW!**
Insure Ample Stocks of Standard Parts by Ordering



Two Very Profitable SPECIALS

Koehler 3-Plate Vernier Variable Condensers

Heavy aluminum plates, thick Bakelite ends, other parts of brass, nickel-plated. .000075 Mfd. capacity. Accurately manufactured and carefully tested. Koehler Condensers have made good. Also made in other sizes.

LIST
\$1.50

GREWOL Crystal Detectors

No trouble selling this fixed detector. Stays adjusted. Guaranteed tested crystal in dust-proof glass cup.

LIST
\$2.00

Test our service with a trial order of these two standard sellers

Write for Attractive Discounts on Our Complete Line

DISTRIBUTORS FOR

Acme
Baldwin
Bradleystat
Chelsea
De Forest
Eveready
Federal
Homcharger
Jefferson
Kosner
Magnavox
Murdock
Paragon
Thordarsen
Tuska
Western
Electric

**WHOLESALE
ONLY**



Wholesale Radio Equipment Co.

24 WILLIAM STREET, NEWARK, N. J.

The RECENT CHICAGO SHOW:

Resulted in quantity orders from concerns ranging from Florida to California on:

THE RADIO BUILDER SET

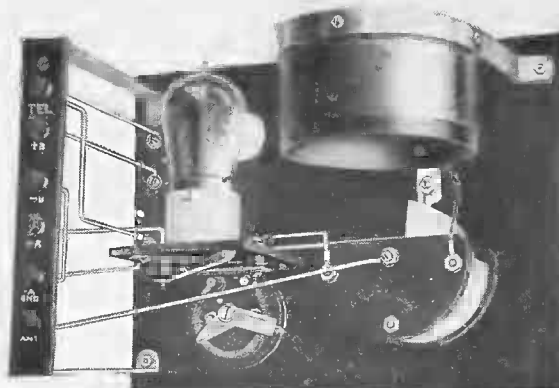
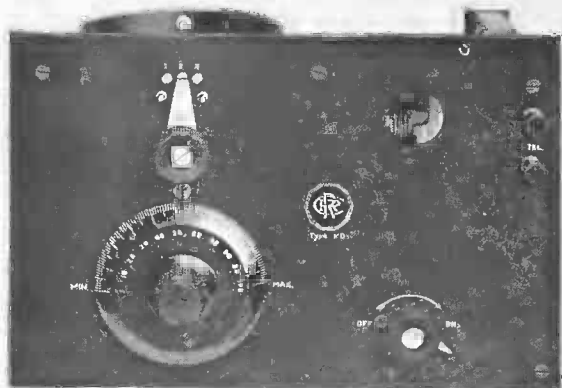

Shipped to customer in "knock-down" form and requiring only a screwdriver and a few moments to *complete* its assembly. When finished it provides a vacuum tube set which is very selective, giving extremely loud and undistorted signals. **\$30.00**

Some dealer propositions still open

The above type set is available in one, two and three tube form

RAYMOND RADIO CORPORATION

Manufacturers to the Radio Industry

Offices: 309 Lafayette Street, New York

Works: Farmingdale, L. I.

JOBBERS! DEALERS! MANUFACTURERS!

We invite your inquiries on the following:

Telephone Plugs

Fixed Condensers

Knock Down Crystal Detectors

Crystal Detectors

Eastern Distributors

"Didaic" Antenna Plug
"Aerial-a" V.T. Receiving Sets
"Grin" Variable Condensers

Write Us for Prices

THE WOLBRACK CO., Inc. (DEPT. C.)

Largest Manufacturers—Distributors of Radio Equipment

1778 Broadway, New York

"From a Contact to a Complete Set"

QUALITY

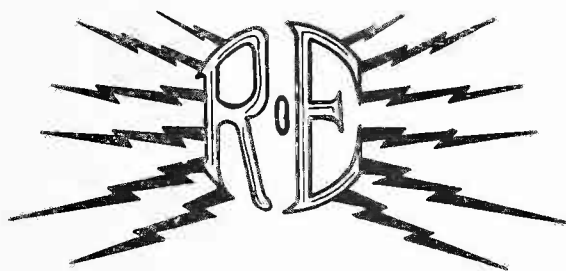

SERVICE



The VT Radiophone Receiver

175-800 Meters

THE Type AD Radiophone Concert Receiver shown in the illustration represents the most compact and modern receiving unit of its size on the radio market today. Developed primarily to meet the demands for an inexpensive but highly finished receiver, it has become extremely popular.

Its compactness and portability have won the favor of Camper and Vacationist. The ease with which it may be installed in the home and the simplicity of its operation have made it a welcome source of enjoyment in domestic circles.

The receiver consists of a single-circuit type, non-regenerative tuner in combination with a vacuum tube detector, extremely sensitive and reliable. The entire set is encased in a genuine Honduras Mahogany Cabinet, beautifully finished and measuring 5¼" x 8¼" x 5" deep. The panel is made of high grade Bakelite rubbed to a dull grain finish. It is machine engraved and the engraving is filled with permanent white. Access to the tube is provided by means of a large circular screen window shown in the top of the cabinet. This feature eliminates the necessity of having a hinged cover and affords much more protection to the interior wiring of the set. The Antenna, Ground and Phone binding posts are the only ones appearing on the front of the panel, all battery connections being made to a small panel in back of the unit.

The Type AC Amplifying Units are characterized by the same high-grade finish employed in the Type AD Receiver. They measure 5¼" x 5¼" x 5" and used in conjunction with the Type AD Receiver. One or more of these units will increase the signal strength considerably and allow the use of loud-speaking devices.

The Type AB Detector shown in the photograph has been designed for those who desire to replace their crystal detectors with the vacuum tube type. It duplicates the Type AC Amplifying Unit in finish and size and is extremely sensitive and reliable.

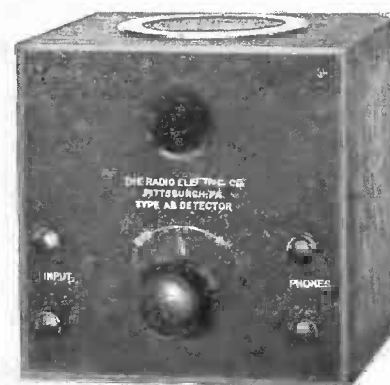

- Type AD Radiophone Concert Receiver (less tube and batteries) \$15.00
- Type AC Amplifier 14.00
- Type AB Detector 9.75

Write for Bulletin RE-3, Describing This Apparatus in Detail

SPECIAL NOTICE

WE are prepared to make measurements of resistance capacity, inductance and insulation at Radio and Audio frequencies. Audibility curves plotted. All work under supervision of experts. Prices moderate. Write for quotations.

THE RADIO ELECTRIC CO.
Manufacturers and Jobbers in

RADIO EQUIPMENT

1427-29 LIBERTY AVENUE
PITTSBURGH, PA.



HEAD TELEPHONES

NO. 52-W.....3200 OHMS
NO. 53-W.....2200 OHMS

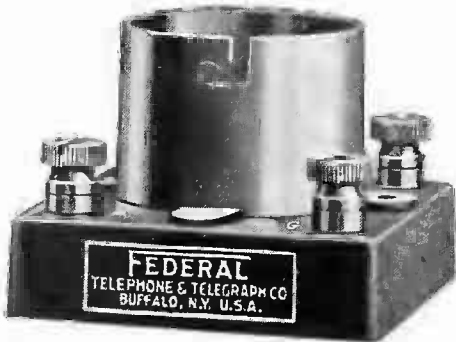

NO. 16 V. T. SOCKET

Federal RADIO APPARATUS

The Recognized **STANDARD** of the World

HEAD TELEPHONES:
VOICE FREQUENCY AMPLIFYING TRANSFORMERS V. T. SOCKETS RHEOSTATS

And many other parts, besides
COMPLETE RECEIVING SETS

All of **Highest Efficiency**

Demand from your dealer
GENUINE FEDERAL APPARATUS
Manufactured by

Federal Telephone & Telegraph Co.

BUFFALO - - NEW YORK

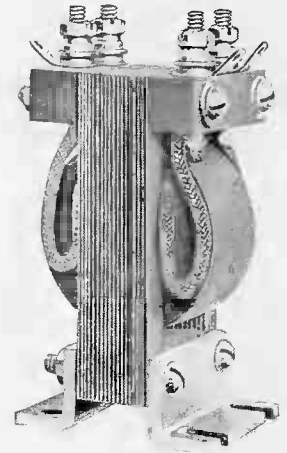

NO. 226-W
VOICE FREQUENCY AMPLIFYING TRANSFORMER



NO. 18 RHEOSTAT

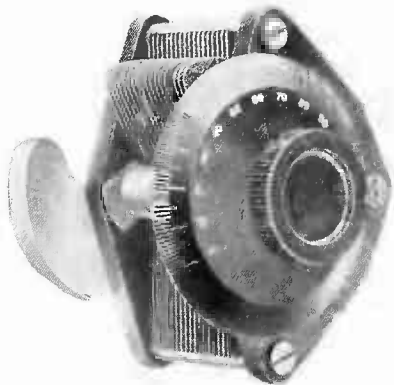

No. 3 Price \$4.75

CHELSEA

Variable Condensers
(Die-Cast Type)

No. 1.—.0011 m. f. mounted \$5.00
No. 2.—.0006 m. f. mounted 4.50
No. 3.—.0011 m. f. unmounted 4.75
No. 3.—.0011 m. f. unmounted, without dial... 4.35
No. 4.—.0006 m. f. unmounted 4.25
No. 4.—.0006 m. f. unmounted, without dial... 3.85

Top, bottom and knob are genuine bakelite, shaft of steel running in bronze bearings, adjustable tension on movable plates, large bakelite dial reading in hundredths, high capacity, amply separated and accurately spaced plates.

Unmounted types will fit any panel and are equipped with counterweight.

Guaranteed for circuits up to 1,000 volts.

Amplifying Transformer No. 50

The Chelsea Amplifying Transformer gives the highest amplification possible and at the same time will not squeal, howl, or in any way cause noisy circuits. It is beautiful in design and embodies electrical characteristics unequalled by any. Guaranteed for all circuits up to 500 volts with a high safety factor. It will not fail in service.



Price \$4.50

Purchase Chelsea Radio Equipment from your dealer. If he does not carry it send to us. Write for our new No. 6 Catalog



Price \$3.00

No. 21. Variable Grid Leak (Patented)

Our variable grid leak consists of ten carefully calibrated values of leak resistance ranging from 1/4 to 5 megohms.

By proper adjustment of the grid leak the potential of the grid and hence the signal strength is accurately controlled. This results in the operation of the tube at its highest efficiency and with the elimination of all squealing and tube noises.

CHELSEA RADIO CO., 150 Fifth Street, Chelsea, Mass.

Manufacturers of Radio Apparatus and Moulders of Bakelite and Condensite

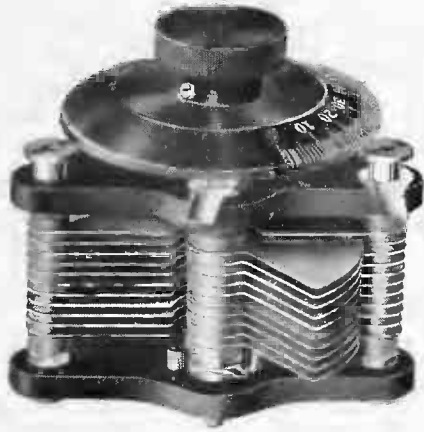

WRITE FOR
RADIO BULLETIN
No. 15

—CHELTEN—

Complete line of Jacks
Radio Plugs
Filament Rheostats
Dials and Knobs
Variable Condensers
Grid Condensers
Phone Condensers
Variable Grid Leaks
V. T. Sockets
Radio Switches
Crystal Detectors
Lightning Arresters
Antenna Receptacles

C. T. R. RADIO
PRODUCTS

Our large manufacturing
facilities combined with
Experience and Craftsmanship
enable us to offer the
BEST

CHELTEN VACUUM TUBE
PANEL UNITS

CHELTEN ELECTRIC CO.

4859-65 STENTON AVE.

PHILADELPHIA, PA.



NATIONAL

SEAMLESS TUBING

in Large Diameters

For Vario-couplers, Variometers, Tuning Coils and wherever you use large diameter fibre tubing, National Seamless Tubing is less expensive and infinitely superior.

National Seamless Tubing is a specially developed, laminated tubing that retains its form and will not warp, swell or shrink. Exact in both diameters and easily worked.

Can be furnished in dark gray fibre, black fibre or dipped in insulating varnish.

Any quantities, diameters from 3" to 4 1/2" I. D. Any wall from 3/32 up.

Give us your specifications. We'll send samples and prices.

National Fibre for Panels

Hard Black Panel Stock of good dielectric strength. Gives satisfaction for condenser tops and bottoms, rheostat bases, washers, bushings, etc. Let us quote on the stock itself, or on completed parts machined to order.

Peerless Insulation

The standard thin weight fibre insulation or "fish paper."

NATIONAL FIBRE & INSULATION CO.

Box 451, YORKLYN, DELAWARE

NEW YORK
CHICAGO
PHILADELPHIA

DETROIT
SAN FRANCISCO

CLEVELAND
OMAHA

PITTSBURGH
BOSTON

ROCHESTER
BIRMINGHAM

ST. LOUIS
BALTIMORE
LONDON, ENGLAND

In CANADA, National Fibre Co. of Canada, Ltd. TORONTO

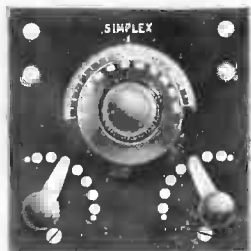

No. 47489
Simplex Vario-Coupler,
Showing Front View of
Panel Mounted Type

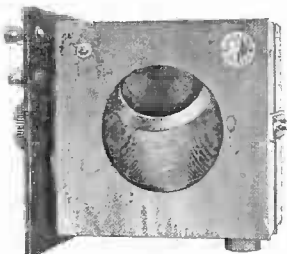

No. 47488
Simplex Variometer,
Showing Side View of
Panel Mounted Type

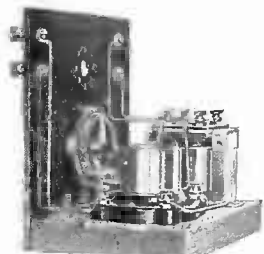

No. 47491
Amplifier Panel — Side
View

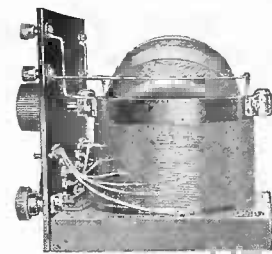

No. 47489
Simplex Vario-Coupler,
Showing Side View of
Panel Mounted Type

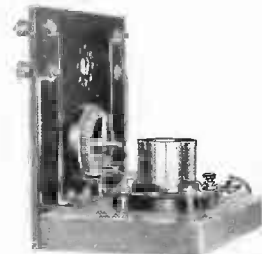

No. 47490
Simplex Detector Panel
Side View

SIMPLEX PANEL UNITS AND KEYSTONE RADIO LIGHTNING ARRESTERS

Write for Dealer Proposition

With Simplex Panel Units the user can easily change his hook-up and thus always have the benefit of the latest ideas in radio circuits. These are high-grade instruments and should be carried in every dealer's stock. Complete data and discounts on request.

Keystone Radio Lightning Arresters are approved by Underwriters; have no vacuum tube which in a short time loses and makes an arrester valueless. Weatherproof, sealed and fool-proof. Thousands and thousands in use. Write for discounts.

Electric Service Supplies Company

*Manufacturers of Lightning
Arresters for 30 years*

Distributors for Simplex Radio Co.

Philadelphia, 17th and Cambria Sts.; Pittsburgh, 829
Oliver Bldg.; Scranton, 316 N. Washington Ave.;
Boston, 88 Broad St.; New York, 50 Church St.;
Chicago, Monadnock Bldg.

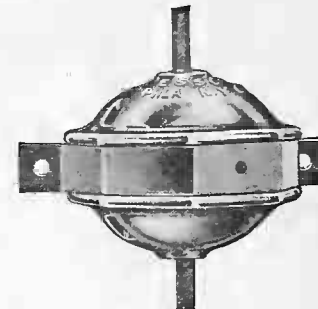

Type A, Keystone Radio
Arrester. Retail Price, \$2.00

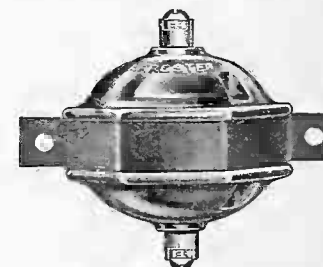

Type B, Keystone Radio
Arrester. Retail Price, \$2.00

"ARTICLES OF TRUE QUALITY ONLY— CORRECTLY PRICED"

SOLE MANUFACTURERS OF

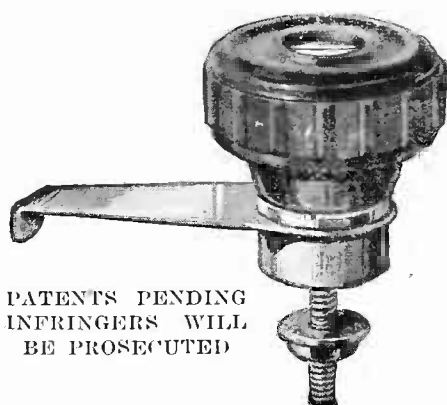

PATENTS PENDING
INFRINGEMENTS WILL
BE PROSECUTED

Fixt-Post
PATENT APPLIED FOR
Positive Contact Switch

NO BUSHINGS—NO LOCK NUTS
CANNOT LOOSEN OR BIND
NO BROKEN OR LOOSE WIRES

Every article added to the Mydar Line must first prove its worth to the entire satisfaction of our engineers—its manufacturer must prove his ability to produce not only at a fair price but also in quantities which will assure prompt deliveries.

Jobbers and retailers specializing in Mydar Products rest secure in the certainty of prompt service and of an unqualified guaranty behind every article.

We manufacture:

- ACCURATUNE—Bank Wound Couplers.
- STANZA-STRAIN—Insulators.
- FIXT-POST—Knob Switches.
- STOPSIT—Switch Stops.

We distribute:

- ACCURATUNE—Variable Condensers (Vernier, Balanced, Table and Regular Types).
- STANDARD—Model 8 Headsets.
- FCM—Insulators, Protectors etc.
- PRESTO—Antenna Superseder.
- REEL-EASY—Products.
- CROFT—Variometers and Vario-couplers.
- G-W—Products.

CATALOG NOW READY—ADDRESS DEPT. NO. 52



845 BROAD STREET, NEWARK, N. J.
WESTERN SALES DEPT.: 8405 DETROIT AVE., CLEVELAND, O.

Are You Making Money Out of Radio ?

THE RADIO TELEPHONE HANDBOOK

By H. G. Cisin, M.E.

TELLS YOU HOW

IT CONTAINS THE FOLLOWING FACTS ABOUT RADIO YOU WANT TO KNOW

What Radio Apparatus to Stock
 What Class of Radio Sets to Handle
 The Operating Principles of Radio
 The Various Types of Radiophone Receivers—the Best Methods of Adjusting Them
 How Crystal Detectors Work
 What Crystals Work Best
 How the Vacuum Tube Works
 What Is Meant by Cascade Amplification

The Principles of Regeneration
 How to Select Telephone Head Sets
 Types and Uses of Tuning Devices
 The Meanings of Everyday Radiophone Terms
 How to Select and Install the Demonstration Set
 What Service to Give in Connection with the Sale of Radiophones
 How to Utilize Newspaper and Other Publicity

With This Book You Can Tell Your Customer

The Best Way to Erect His Aerial
 Which Is Preferable, a One or a Four-Wire Aerial.
 What Determines the Length of the Aerial
 Underwriters' Requirements
 License Requirements
 How Best to Protect Against Lightning
 Why Some Radio Sets Are Simple and Others Are Complicated
 Which Sets to Recommend
 What Batteries, if Any, Are Necessary
 How High to Put the Aerial
 When an Indoor Aerial Can Be Used
 Under What Circumstances Ground Connection May Be Dispensed With
 When a Loud Speaker May Be Used
 What the Loop Aerial Is

How Amplification May Be Obtained
 Whether a Vacuum Tube May Be Used in Conjunction With a Crystal Detector
 Whether More Than One Radio Receiving Set May Be Connected to the Same Aerial
 The Correct Way to Measure Aerial Length
 When Shielding Is Necessary
 How to Check Up the Condition of the Storage Battery
 How to Eliminate Howling
 Causes and Remedies for Weak Signals and Local Noises in Connection with Vacuum Tube Sets
 How to Locate Faults in Vacuum Tube Radiophone Receiving Sets

Single Copies Price \$1.00
 One Dozen Lots 33% discount
 Four Dozen Lots 40% discount

Special Discounts on Quantity Orders

Attractive Exclusive Proposition for Distributors

Published By

THE ALLIED ENGINEERING INSTITUTE
 1400 Broadway, NEW YORK CITY

FILL THIS OUT, TEAR OFF AND MAIL

THE ALLIED ENGINEERING INSTITUTE
 NEW YORK, N. Y.

GENTLEMEN:
 SEND COPIES OF
 THE RADIO TELEPHONE
 HANDBOOK FOR WHICH
 FIND ENCLOSED \$.....
 NAME.....
 ADDRESS.....
 CITY.....
 STATE.....

Let Our Free Service Bureau Help You Supply Your Needs

Tell us your needs and we'll put you in touch with reputable firms to the end that you will receive information on the latest and best equipment. A post card will do or use the coupon below.

- | | | | | |
|---------------------------------------------------------------------------------------------------------------------------------------------------------------------------------------------------------------------------------------------------------------------------------------------------------------------------------------------------------------------------------------------------------------------------------------------------------------------------------------------------------------------------------------------------------------------------------------------------------------------------------------------------------------------------------------------------------------------------------------------------------------------------------------------------------------------------------------------------------------------------------------------------------------------------------------------------------------------------------------------------------------------------------------------------------------------------------------------------------------------------------------------------------------------------------------------------------------------------------------------------------------------------------------------------------------------------------------------------------------------------------------------------------------------------|-----------------------------------------------------------------------------------------------------------------------------------------------------------------------------------------------------------------------------------------------------------------------------------------------------------------------------------------------------------------------------------------------------------------------------------------------------------------------------------------------------------------------------------------------------------------------------------------------------------------------------------------------------------------------------------------------------------------------------------------------------------------------------------------------------------------------------------------------------------------------------------------------------------------------------------------------------------------------------------------------------------------------------------------------------------------------------------------------------------------------------------------------------------------------------------------------------------------------------------------------------------------------------------------------------------------------------------------------------------------------------------------------------------|-----------------------------------------------------------------------------------------------------------------------------------------------------------------------------------------------------------------------------------------------------------------------------------------------------------------------------------------------------------------------------------------------------------------------------------------------------------------------------------------------------------------------------------------------------------------------------------------------------------------------------------------------------------------------------------------------------------------------------------------------------------------------------------------------------------------------------------------------------------------------------------------------------------------------------------------------------------------------------------------------------------------------------------------------------------------------------------------------------------------------------------------------------------------------------------------------------------------------------------------------------------------------------------------------------------------------------------------------------------------------------------------|---------------------------------------------------------------------------------------------------------------------------------------------------------------------------------------------------------------------------------------------------------------------------------------------------------------------------------------------------------------------------------------------------------------------------------------------------------------------------------------------------------------------------------------------------------------------------------------------------------------------------------------------------------------------------------------------------------------------------------------------------------------------------------------------------------------------------------------------------------------------------------------------------------------------------------------------------------------------------------------------------------------------------------------------------------------------------------------------------------------------------------------------------------------------------------------------------------------------------------------------------------------------------------------------------------------------------------------------------------------------------------------------------------------------------------------------------------------------------------------------------------------------------------------------------------------------|----------------------------------------------------------------------------------------------------------------------------------------------------------------------------------------------------------------------------------------------------------------------------------------------------------------------------------------------------------------------------------------------------------------------------------------------------------------------------------------------------------------------------------------------------------------------------------------------------------------------------------------------------------------------------------------------------------------------------------------------------------------------------------------------------------------------------------------------------------------------------------------------------------------------------------------------------------------------------------------------------------------------------------------------------------------------------------------------------------------------------------------------------------------------------------------------------------------------------------------------------------------------------------------------------------------------------------------------------------------------------------------------------------------------------------------------------------------------------------------------|
| <p>A</p> <p>1 "A" Batteries
2 Aerials
3 Aerial wire
4 Aerial protectors
5 Aerial switches
6 Aerial insulators
7 Aerials, loop
8 Air condensers
9 Adapters
10 Amplifiers
11 Amplifying units
12 Aluminum wire
13 Ammeters
14 Amplifying tubes
15 Amplifying horns
16 Amplifying transformers
17 Antennae, cage
20 Antenna light wire plugs
18 Audio frequency transformers
19 Automatic transmitters</p> <p>B</p> <p>21 "B" Batteries
22 Batteries, "A"
23 Batteries, dry
24 Batteries, storage
25 Battery chemicals
26 Battery chargers
27 Battery testing instruments
28 Battery switches
29 Battery rheostats
30 Battery clips
31 Battery handles
32 Battery potentiometers
33 Binding posts
34 Books
39 Boxes
35 Brass parts
36 Bushings
37 Bulbs
38 Buzzers</p> <p>C</p> <p>41 Cabinets
42 Cam switches
43 Carbon potentiometers
44 Change-over switches
45 Charging rectifiers
46 Choke coils
47 Cat whiskers
48 Cap nuts
49 Carbon walls
50 Cardboard tubes
78 Charts
51 Chopper, rotary
52 Clamps
53 Clips
54 Coils
55 Coil mountings
56 Coil plugs
57 Coils, spark
58 Condensers
59 Condensers, fixed
60 Condensers, variable
61 Condensers, air</p> | <p>62 Condensers, mica
63 Condensers, loading
64 Connection blocks
77 Contract work
65 Control panels
66 Condenser parts
67 Copper wire
68 Cords
69 Cord tips
70 Crystals
71 Crystal detector units
72 Crystal receiving sets
73 C. W. Transmitter sets
74 C. W. Filament heated transformers
75 C. W. Inductances
76 C. W. Power transformers</p> <p>D</p> <p>81 Detectors
82 Detector panels
83 Detector tubes
84 Detector minerals
85 Detector units
86 Dictionary, Radio
87 Dials
80 Dial switches
88 Dry batteries
89 Drawings
90 Diagrams</p> <p>E</p> <p>91 End mountings (tubes)
92 Engraving
93 Electrotypes</p> <p>F</p> <p>95 Fibre spools
96 Fan switches
97 Filter reactors
98 Fixed condensers
99 Fire extinguishers
100 Filament rheostat
101 Filter coils
102 Flashlights
103 Fuse terminals</p> <p>G</p> <p>106 Gaps, Spark
107 Generators
105 Glass
108 Grid condensers
109 Grid leaks
110 Grid leaks, variable
111 Grid coils
112 Ground clamps
113 Ground wires
114 Ground switches</p> <p>H</p> <p>116 Headsets and bands
117 Honeycomb coils
118 Honeycomb mountings
119 Honeycomb plugs
120 Hook switches
121 Horns
122 Hydrometers</p> | <p>I</p> <p>126 Indicators
127 Inductances, C. W. Transmitting
128 Insulators
129 Insulation
130 Invention developments</p> <p>J</p> <p>131 Jacks</p> <p>K</p> <p>132 Knock down units</p> <p>L</p> <p>136 Lead-in wire
137 Lead-in switches
138 Lead-in bushings
139 Lead-in insulators
140 Levers, Switch
141 Lightning arrestors
142 Lightning switches
143 Loading coils
144 Loading inductance
145 Loose couplers
146 Loud speakers
147 Locked lever switches
148 Lock nuts
149 Loop aerials
150 Lugs</p> <p>M</p> <p>313 Mailing lists
314 Metals
151 Magnetic modulator
152 Modulation transformers
153 Machine screws
154 Magnet wire
155 Magazines, Radio
156 Mica
157 Mica diaphragms
158 Mica condensers
159 Mica diaphragm transformers
160 Microphone transformers
161 Milliammeters
162 Milli-voltmeters
163 Motors
164 Motor generators
165 Mounting coils
166 Minerals
167 Mountings</p> <p>N</p> <p>171 Name plates
172 Nickel parts
173 Nuts</p> <p>O</p> <p>176 One stage amplifier units
177 Oscillation transformers</p> <p>P</p> <p>178 Panels
179 Panel plugs
180 Panel controls
181 Paper tubes
311 Patent registration</p> | <p>182 Patent wire
183 Patent wire terminals
184 Plans
185 Phonograph attachments
186 Plate condensers
187 Porcelain
188 Porcelain cleats
189 Porcelain insulators
190 Porcelain mountings
191 Porcelain tubes
192 Porcelain V. T. receptacles
193 Porcelain V. T. sockets
194 Precision instruments
195 Polarity indicators
196 Plate connectors
197 Paste solder
198 Phosphor-bronze wire sheets</p> <p>Q</p> <p>307 Quenching spark gaps</p> <p>R</p> <p>308 Radio books
309 Radio schools
310 Radio publications
199 Radio frequency transformers
200 Reactor, plate circuit
201 Reactor, filter
202 Receiving sets
203 Receiving head sets
204 Receiving transformers
205 Receptors
206 Receiver magnets
207 Rectifiers
208 Rectifying tubes
209 Regenerative sets
210 Rheostats
211 Rheostat wire
212 Rods
213 Rotary lever switches
214 Rotary spark gaps
215 Rotary variable condensers
216 Rubber parts
217 Rotors</p> <p>S</p> <p>221 Safety switches
222 Safety fuses
223 Sliders and rods
224 Sockets
225 Soft metal
226 Shielded dials
227 Short wave sets
228 Solder
229 Solder, bar
312 Soldering irons (electric)</p> <p>230 Spark transformers
231 Spark coil selectors
232 Spaghetti tubing
233 Special apparatus
234 Spark gaps
235 Spring clips
236 Storage batteries
237 Sectional receiving sets</p> | <p>238 Switches
239 Switch levers
240 Switch points
241 Symbols</p> <p>T</p> <p>246 Tapes
247 Telephone cord
248 Telephone plugs
249 Telephone receivers
250 Telegraph keys
251 Telegraph teachers
252 Testing instruments
253 Testing clips
254 Terminals
255 Thermometers
256 Tools
257 Trade marks
258 Transformers
259 Transmitters
260 Transmitting sets
261 Towers
262 Three coil mounting
263 Tin foil
264 Tuning coils
265 Tubes, amplifier
266 Tubes, detector
267 Tuning, flexible
268 Tube sockets
269 Tubes
270 Tuner and detector cabinets
271 Two stage cabinets
272 Two stage amplifier unit</p> <p>U</p> <p>276 Unit type receiving sets
277 Unassembled sets</p> <p>V</p> <p>281 Vacuum tubes
282 Vacuum tube sockets
283 Variable condensers
284 Variometers
285 Vario couplers
286 Variable grid leak
287 Vernier adjusters
288 Vibrators
289 Vocaloids
290 Voltmeters
291 Vulcanized fibre sheets
292 V. T. receiving sets
293 Variogrid leak
294 V. T. detector units
295 V. T. control units
296 V. T. receptacle</p> <p>W</p> <p>297 Washers
298 Watch case receivers
299 Wattmeters
300 Wave meters
301 Wave tuner
302 Wire
303 Wire, aerial
304 Wire phosphor bronze
305 Wire, copper clad
306 Wire, magnet</p> |
|---------------------------------------------------------------------------------------------------------------------------------------------------------------------------------------------------------------------------------------------------------------------------------------------------------------------------------------------------------------------------------------------------------------------------------------------------------------------------------------------------------------------------------------------------------------------------------------------------------------------------------------------------------------------------------------------------------------------------------------------------------------------------------------------------------------------------------------------------------------------------------------------------------------------------------------------------------------------------------------------------------------------------------------------------------------------------------------------------------------------------------------------------------------------------------------------------------------------------------------------------------------------------------------------------------------------------------------------------------------------------------------------------------------------------|-----------------------------------------------------------------------------------------------------------------------------------------------------------------------------------------------------------------------------------------------------------------------------------------------------------------------------------------------------------------------------------------------------------------------------------------------------------------------------------------------------------------------------------------------------------------------------------------------------------------------------------------------------------------------------------------------------------------------------------------------------------------------------------------------------------------------------------------------------------------------------------------------------------------------------------------------------------------------------------------------------------------------------------------------------------------------------------------------------------------------------------------------------------------------------------------------------------------------------------------------------------------------------------------------------------------------------------------------------------------------------------------------------------|-----------------------------------------------------------------------------------------------------------------------------------------------------------------------------------------------------------------------------------------------------------------------------------------------------------------------------------------------------------------------------------------------------------------------------------------------------------------------------------------------------------------------------------------------------------------------------------------------------------------------------------------------------------------------------------------------------------------------------------------------------------------------------------------------------------------------------------------------------------------------------------------------------------------------------------------------------------------------------------------------------------------------------------------------------------------------------------------------------------------------------------------------------------------------------------------------------------------------------------------------------------------------------------------------------------------------------------------------------------------------------------------|---------------------------------------------------------------------------------------------------------------------------------------------------------------------------------------------------------------------------------------------------------------------------------------------------------------------------------------------------------------------------------------------------------------------------------------------------------------------------------------------------------------------------------------------------------------------------------------------------------------------------------------------------------------------------------------------------------------------------------------------------------------------------------------------------------------------------------------------------------------------------------------------------------------------------------------------------------------------------------------------------------------------------------------------------------------------------------------------------------------------------------------------------------------------------------------------------------------------------------------------------------------------------------------------------------------------------------------------------------------------------------------------------------------------------------------------------------------------------------------------------------------------------------------------------------------------|----------------------------------------------------------------------------------------------------------------------------------------------------------------------------------------------------------------------------------------------------------------------------------------------------------------------------------------------------------------------------------------------------------------------------------------------------------------------------------------------------------------------------------------------------------------------------------------------------------------------------------------------------------------------------------------------------------------------------------------------------------------------------------------------------------------------------------------------------------------------------------------------------------------------------------------------------------------------------------------------------------------------------------------------------------------------------------------------------------------------------------------------------------------------------------------------------------------------------------------------------------------------------------------------------------------------------------------------------------------------------------------------------------------------------------------------------------------------------------------------|

Note the number of the item you want to buy—then check the corresponding number in the coupon below and mail to us.

TEAR OFF HERE

1	2	3	4	5	6	7	8	9	10	11	12	13	14	15	16	17	18	19	20	21
22	23	24	25	26	27	28	29	30	31	32	33	34	35	36	37	38	39	40	41	42
43	44	45	46	47	48	49	50	51	52	53	54	55	56	57	58	59	60	61	62	63
64	65	66	67	68	69	70	71	72	73	74	75	76	77	78	79	80	81	82	83	84
85	86	87	88	89	90	91	92	93	94	95	96	97	98	99	100	101	102	103	104	105
106	107	108	109	110	111	112	113	114	115	116	117	118	119	120	121	122	123	124	125	126
127	128	129	130	131	132	133	134	135	136	137	138	139	140	141	142	143	144	145	146	147
148	149	150	151	152	153	154	155	156	157	158	159	160	161	162	163	164	165	166	167	168
169	170	171	172	173	174	175	176	177	178	179	180	181	182	183	184	185	186	187	188	189
190	191	192	193	194	195	196	197	198	199	200	201	202	203	204	205	206	207	208	209	210
211	212	213	214	215	216	217	218	219	220	221	222	223	224	225	226	227	228	229	230	231
232	233	234	235	236	237	238	239	240	241	242	243	244	245	246	247	248	249	250	251	252
253	254	255	256	257	258	259	260	261	262	263	264	265	266	267	268	269	270	271	272	273
274	275	276	277	278	279	280	281	282	283	284	285	286	287	288	289	290	291	292	293	294
295	296	297	298	299	300	301	302	303	304	305	306	307	308	309	310	311	312	313	314	315

Service Bureau The Radio Dealer,
1133 Broadway, New York City.

We are interested in buying radio equipment and have circled the numbers on this coupon of the items we are ready to buy now. Please have manufacturers of these lines quote us dealers' prices.

Name

Address

We are
—Retailers
—Jobbers
—Manufacturers
1922

The New Armstrong Super Regenerative Receiver

How to Construct and Operate It With Twelve Photos and Diagrams of Sets Actually Constructed by the Author. The Only Authentic Book

By **KENNETH HARKNESS**

Price, 50 Cents

At your Dealer or direct from the Publishers

256 West 34th STREET

The Radio Guild, Inc.

NEW YORK CITY

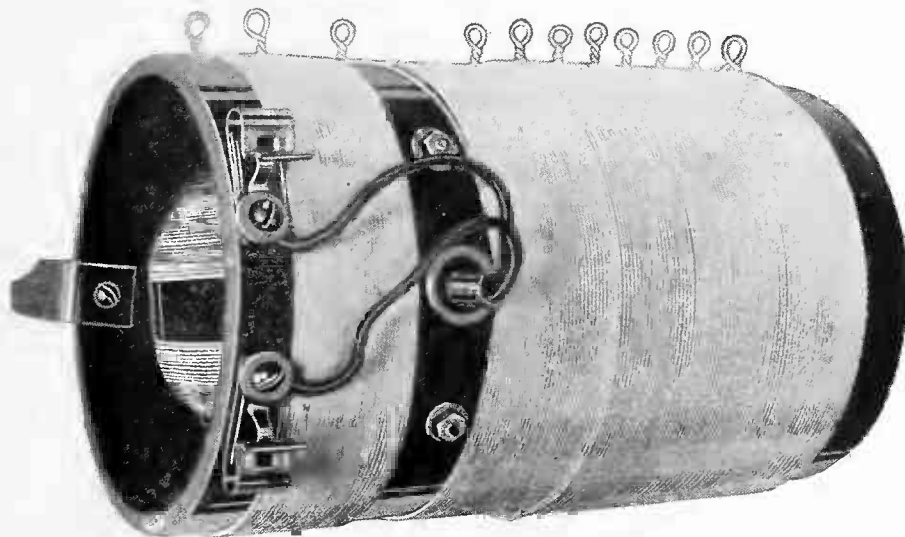

Manufacturers of

THE VOX HUMANA

The Receiver with the Living Voice

The Radio Guild

ALL RANGE COUPLER

150-3400 Meters—Bank Wound

Certificate of Excellence from The New York Mail and Radio Institute

List Price, \$9.00

DEALERS—Write for special proposition.

The Radio Guild, Inc. Phone: Longacre 10279 **256 West 34th St., New York City**

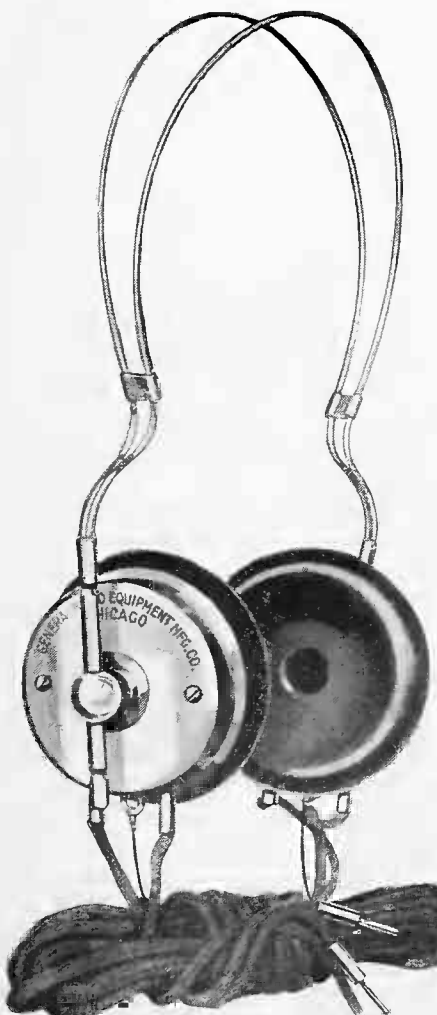

The A. C. Impedance of Our Phones Is More Closely Co-ordinated and Synchronized with All Makes of Standard Tubes Than Any Other

SPECIFICATIONS

Weight of two phones and head band—10½ oz.
 Shell—Made of finest grade of aluminum, highly polished.
 Magnets—Made of highest percentage tungsten steel.
 Magnet Coil Cores—Made of best grade of soft Norway iron.
 Magnet Wire—Best grade, enamel insulated.
 Magnet Shield—Polished nickeloid.
 Bobbin Heads—Polished nickeloid and fibre.
 Diaphragm—Special hard rolled, enameled and polished.
 Terminals—Positive connections, knurled posts imbedded in highest grade hard fibre.
 Winding—Each coil with exactly the same number of ampere turns.
 Adjustment—Precision to the thousandth of an inch.
 Testing—Each coil measured by wheatstone bridge. Each phone set matched in tone and sensitivity. Each phone radio tested.
 Head Band—Music wire nicked and polished. Feather weight (1¼ oz.). Lightest made. Proper and permanent tension. Holds phones securely, excluding all outside noise, yet with perfect comfort to wearer. No fabric covering to become soiled and unsanitary. Perfect adjustment feature of spring and ball tension holds phones at desired point, yet permits adjustment to be changed by slight pressure at proper point.
 Cord—Highest grade double conductor cord with anchor extension to remove any strain from terminal points.
 Finish—Each and every part, inside and out, is made and finished in the very best workmanship manner, pleasing to the eye as well as the ear. No detail is too small to receive the closest attention and finest workmanship.
 Results—Extra powerful, sensitive and radio perfect. No distortion, blasting or rasping of tones. Each tone reproduced with scrupulous fidelity. No sacrifice of tone quality has been made in order to obtain loudness, yet obtaining ample volume and loudness, up to the degree possible to be had without distortion. Tones come in as clear as a silver bell, the most perfect sound reproduction ever obtained. A work of highest electrical and mechanical art—meeting the most exacting demands of the best posted radio authorities.

2000 ohm Monocoil Set	\$6.00
2400 ohm Red Star Professional Set.	8.00
3200 ohm Red Star Long Distance Set.....	10.00

Attractive discount and strong cooperation for jobbers and dealers.

General Radio Equipment Mfg. Co.

1143-45 Diversey Parkway

Chicago, Ill., U. S. A.

To the Manufacturer and Dealer in Radio Equipment

We offer a specialized Engineering and Testing Service covering—

Testing and rating of equipment
 Designing of instruments and parts
 Patent search
 Plant design, production methods and cost finding

Have your radio equipment rated according to GREGG STANDARDS in preparation for the Fall business.

GREGG AND COMPANY

St. Louis, Mo.
 Newark, N. J.

Engineers

Radio Department

165 Broadway

New York City

Washington, D. C.

Los Angeles, Cal.

Mexico City, Mexico

THE MOST DESIRABLE PHONE IN THE WORLD

STANDARD MODEL 8
 RADIO TELEPHONE

HEAD SETS
 2500 Ohms

The outstanding feature of our phones is that they have laminated pole pieces, which stores up a greater magnetic force. These pole pieces are adjustable, which makes it possible to adjust each phone to receive alike, at the final test in the factory.



RETAIL PRICE
\$5.75

STANDARD MODEL 8
 RADIO TELEPHONE

HEAD SETS
 2500 Ohms

Our phones have been thoroughly tested, and we guarantee them to be equal to any phone on the market listing at \$8.00.

The adjustable polepiece feature make them adaptable for use with any stage of amplification.

NOTE.—The makers of these phones have manufactured electrical measuring instruments for the past 15 years

DISTRIBUTORS AND JOBBERS—WRITE FOR PRICES

STANDARD ELECTRIC SALES CO.

843 BROAD STREET,

NEWARK, N. J.

“Distinctive Radio Apparatus”

THE ROBBINS VARIABLE CONDENSER

43 Plate
— .001 mfd.

\$4.00

23 Plate
— .0005 mfd.

\$3.25

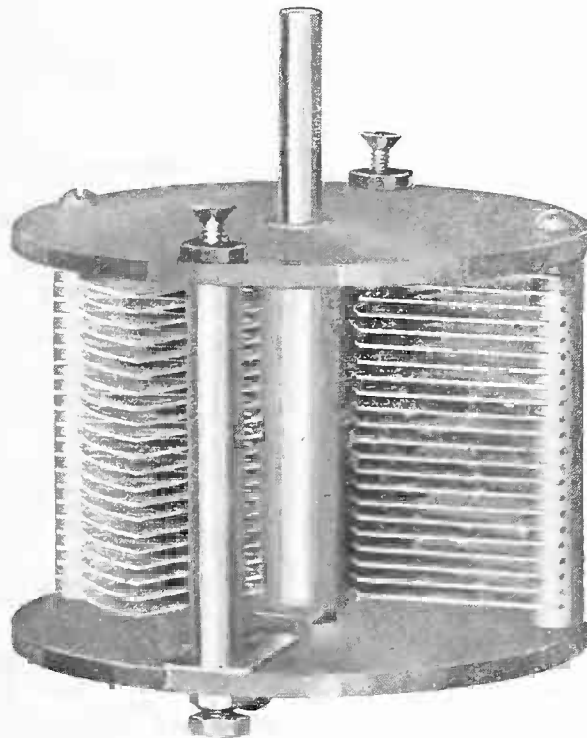

11 Plate
— .00025 mfd.

\$2.75

3 Plate
— Vernier

\$1.50

Die cast and machined throughout (not built up with washers); round bakelite ends, affording ample protection for plates; tension adjustment; mounted on metal bearings, thus preserving alignment; specially rolled aluminum plates; wonderfully well built throughout, insuring maximum sensitivity. Attractive proposition for jobbers and dealers.

Apparatus Ready for Delivery (Subject to Prior Sale)

Receiving Sets

Westinghouse RC Set.....	\$132.50
General Electric Tuner.....	50.00
General Electric Detector-Amplifier.....	75.00
Westinghouse Aeriola Sr.....	65.00
Westinghouse Aeriola Jr.....	25.00
Deforest Radiohome Set.....	36.00
Deforest Radiohome Amplifier.....	35.00

Herbert H. Frost Apparatus

Cord Tip Plug No. 137.....	\$1.25
Single Circuit Jack No. 133.....	.65
Closed Circuit Jack No. 134.....	.75
Double Circuit Jack No. 131.....	.90
Filament Control S.C. Jack No. 135.....	1.00
Filament Control D.C. Jack No. 136.....	1.25

Phones

Frost 2000 ohm.....	5.00
Frost 3000 ohm.....	6.00
Murdock 2000 ohm.....	5.00
Murdock 3000 ohm.....	6.00
Brandes Superior.....	8.00
Holzer-Cabot.....	8.00
Western Electric 1004-c.....	12.00
Brandes Navy.....	14.00
Seibt.....	14.00
Western Electric.....	15.00

Loud Speakers

Magnavox R-3.....	45.00
Magnavox R-2.....	85.00
Magnavox AC-2 Power Amplifiers.....	80.00
Magnavox AC-3 Power Amplifiers.....	110.00
Western Electric Complete.....	161.00
Westinghouse Vocorola.....	30.00

Vacuum Tubes

Radiotron or Cunningham Detectors.....	5.00
Radiotron or Cunningham Amplifiers.....	6.50
Radiotron or Cunningham 5 Watt.....	8.00

Immediate Shipments. Send for Price List and Discount Sheet

ROBBINS ELECTRIC CO.
PITTSBURGH
Established 1890

NELSON RADIOFONE RECEIVER

TYPE RS-1

*Scientific Design
Excellent Workmanship
Superior Finish
Efficient Performance*

List Price, - - \$100.00
Without Cabinet, - 95.00

Size, 13" x 19" x 8"

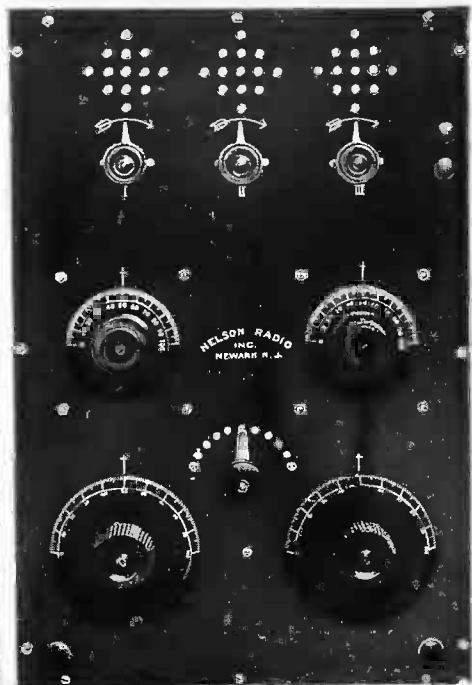

Front View

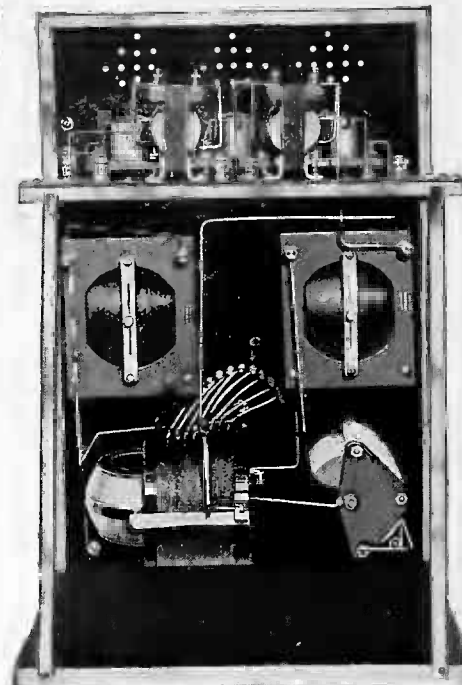

Back View

VARIO COUPLER

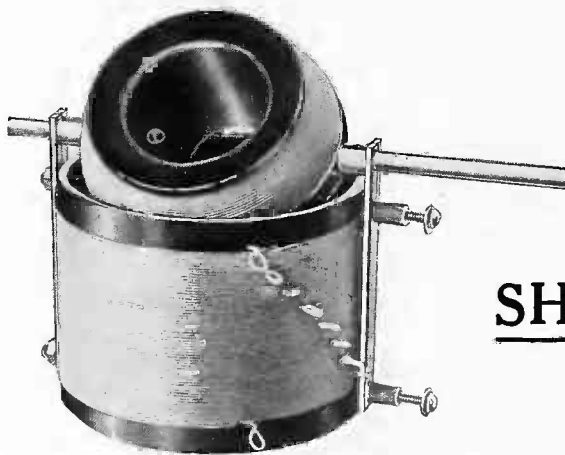

List Price, - - - \$3.50

VARIOMETER

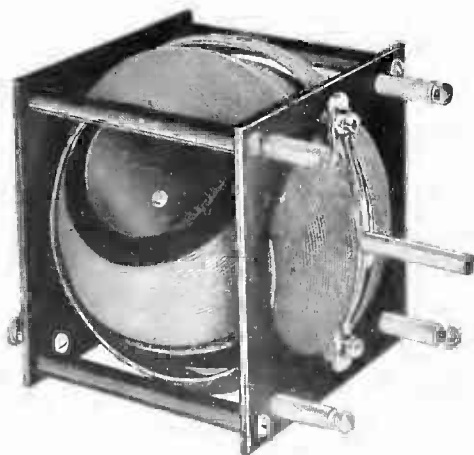

Unique in Design—Efficient in Operation

List Price, - - \$4.50

SHORT WAVE UNIT

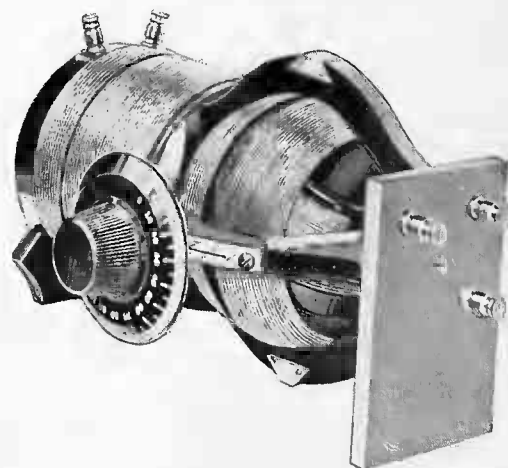

An Exclusive Utility Combination

List Price, - - - \$10.00

*Dealers and Jobbers
Write for Particulars*

NELSON RADIO PARTS CO.

89 ACADEMY STREET,

NEWARK, N. J.

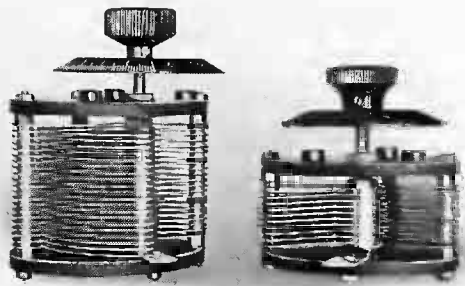

“FARADION”

Variable Condensers of Quality

Designed by J. B. Elenschneider, for over ten years Engineer for the Marconi Wireless Telegraph Co. of America.

These condensers are designed and constructed so as to embody features found only in instruments for commercial and professional use.

Already some of the manufacturers of high grade regenerative receivers have adopted our condenser for their sets.

The condensers are constructed of the highest grade material and with best workmanship. Insulating ends of high dielectric strength.

Plates of fine hard aluminum, shaped so as to give a straight line increase of wave length and minimum capacity when the condenser is in its open position.

Shafts, spacers, rods and nuts, and so forth, turned to precision—not stamped.

Each condenser fully guaranteed.

9 plates cap. .00025 M. F. list price \$3.50.

21 plates cap. .00066 M. F. list price 4.75.

41 plates cap. .0011 M. F. list price 5.75.

Knobs or dials extra.

Manufacturers, jobbers, dealers, write for discount.

Can make prompt deliveries.

RADIO LABORATORIES OF NEW JERSEY, INC., CRANFORD, N. J.



Premier

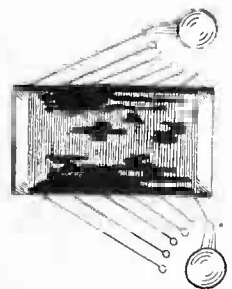
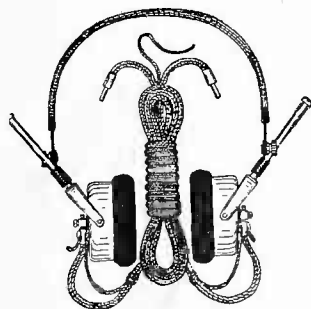
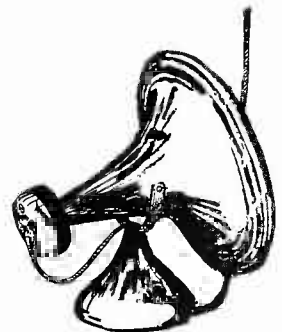

PREMIER ACCESSORY & SPECIALTY CORP.

DUPLEX LIGHT MANUFACTURING AND METAL STAMPING PHONES

2000 Ohms

\$6.50

LIST

29 CONGRESS ST., NEWARK, N. J.

WRITE FOR DISCOUNTS

3000 Ohms

\$8.00

LIST

!!! THE PREMIER RADIOVOICE !!!

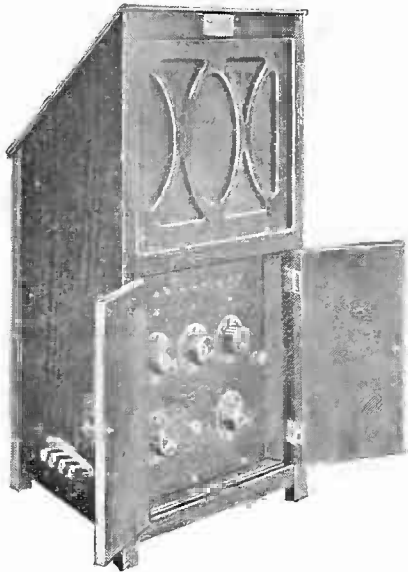

Is the first practical and commercial accomplishment of meeting the public's requirements and demand for a *Complete, Simple, Compact, Attractive and Efficient Loud Talking-Detector and 2-Stage Radio Receiver* at a Popular Price, Simple in Control—Wide in Range.

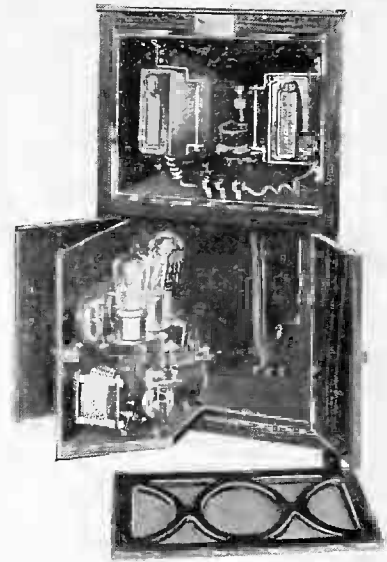

Mounted on a Bakelite Panel are Premier Built and Tested Radio Condensers, Rheostats, V. T. Sockets, Transformers, Tuning Coils, Jacks, etc; the panel being hinged within the beautiful 5 ply Mahogany Veneer Loud Talker Cabinet, measuring 21" in height by 12" in width, weighing, completely equipped with "B" Batteries and Loud Talking Phone as shown, only 17 lbs. Can be set in a corner of the living room, on library or end table, or on a piano, blending into the richest of furnishings with equal attractiveness. Price complete, excluding only bulbs and "A" battery—\$95.00.

Where an even lower priced equipment is desired, eliminating the phone and loud talker cabinet, our Type P equipment, including "B" batteries, mounted in cabinet as shown, parts, hookup and panel being identical to that used in the Premier Radiovoice, is priced at \$55.00.

The Premier Radio Corporation is an old electrical manufacturing concern, which has turned its entire resources and equipment to production of high class radio parts and receiving sets. The Premier line is handled and is available to only the highest class of dealer, jobber or distributor, and to such is offered discounts to permit profitable merchandising. Descriptive bulletins sent on request.

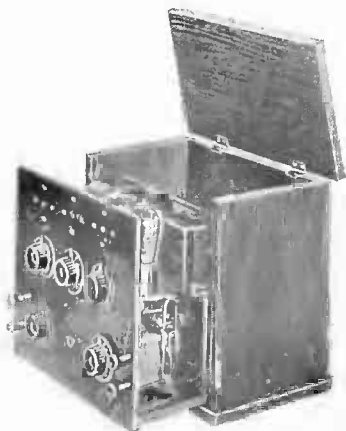

PREMIER RADIO CORPORATION

6800 BOSTWICK AVE.
DETROIT, MICH.



RADIO EQUIPMENT SERVICE

(Trade Name Registered)

Offers an Exceptional
Proposition to Dealers

Write for Details

Distributors of
a Complete
Line

500 FIFTH AVENUE
NEW YORK CITY

RADIO EQ SER

ANNOUNCES

RADI

Registered U. S.

A SENSATION IN THE

Receives Market Reports, Current Events, News Items, Lec

COAST T

And Flashes Your

“BROAD

With Force

ESPECIALLY ADAPTED TO INDOOR OR OUTDOOR

Name, Construction and Design

FOR STATE RIGHTS PROPOSITION

RADIO EQUIP

National Distributors

EQUIPMENT VICE

OLITE

Patent Office

WORLD OF ADVERTISING

Features and Entertainment from Famous Broadcasting Stations

COAST

ADVERTISING

CAST"

and Dignity

ADVERTISING, OR THE HOME BEAUTIFUL

Protected by Patents Pending

WRITE OR WIRE AT ONCE

EQUIPMENT SERVICE

500 Fifth Ave., New York City

Gilbert Radio Apparatus

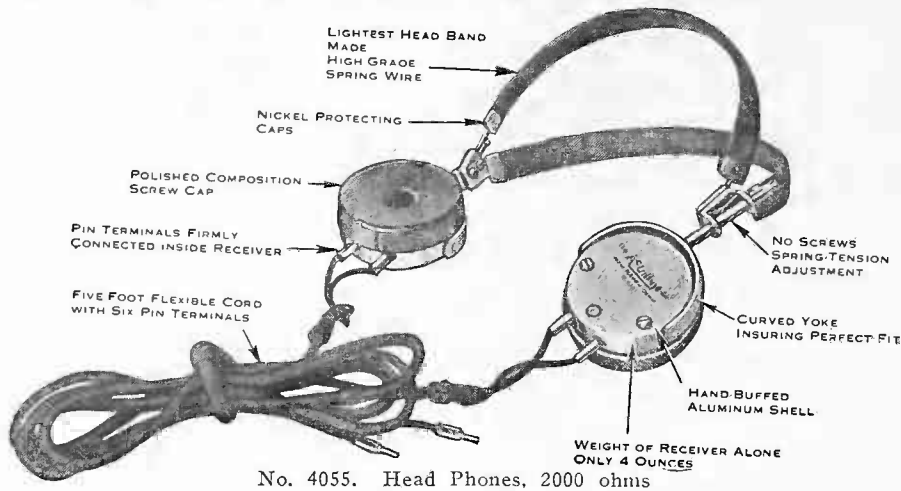

No. 4055. Head Phones, 2000 ohms

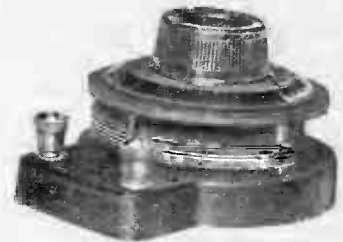

No. 4082. Variable Condenser

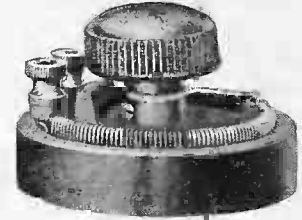

No. 4088. Rheostat

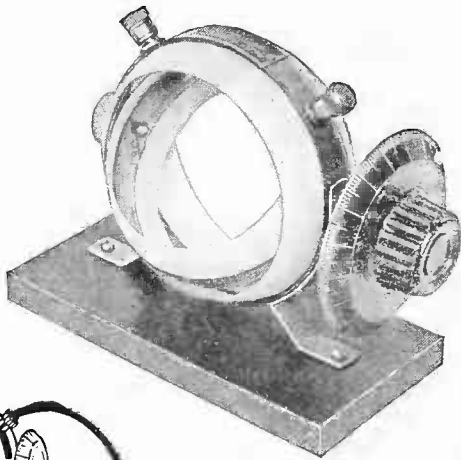

No. 4084. Variometer

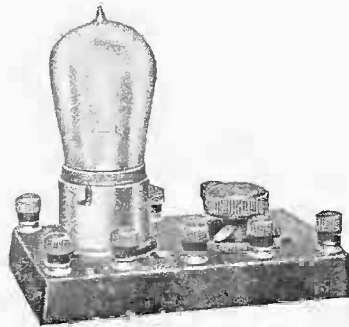

No. 4079. V. T. Control

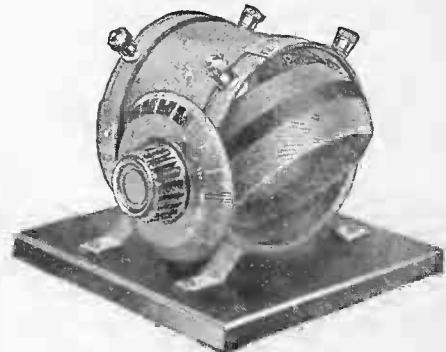

No. 4085. Variocoupler



Quality Radio Parts at Popular Prices

Gilbert Radio Parts represent the very latest developments in the science Radio. They are scientifically constructed instruments, carefully and sturdily built, and so designed that even the novice can build a Radio Receiver second to none. All of the most necessary and advanced parts are included in the Gilbert Line, some of which are illustrated above.

In keeping with the usual Gilbert Policy, they are backed by a sales compelling advertising campaign—popular priced and show a splendid margin of profit. Be ready for the big radio demand this Fall. Put in your stock the line that means rapid turnover and big profits.

Write for Catalog No. 54, just off the press

THE A. C. GILBERT COMPANY

DEPT. C

NEW HAVEN, CONN.

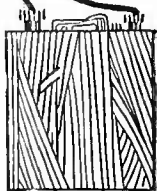

THE RADIO DEALER

The Radio Trade Journal

For The Radio Retailer

CONTENTS AUGUST, 1922

SPECIAL ARTICLES

Armstrong Circuit Pointers.....	By S. E. Tupper	99
"Ask Our Service Bureau".....	By B. B. Stern	68
Dealer Should Avoid Fear Advertising.....	By James Weir	36
Few Pointers in This New Business.....	By Adrian Good	32
Have You Ideas?.....	By Zoltan H. Polachek	23
Increased Interest to Be on Sounder Basis.....	By Charles H. Lehman	26
Maker of Auto Parts Has Remarkable Rise in Radio.....	By R. F. Stayman	27
Making Money in the Radio Business.....	By H. G. Cisin	27
Many Join National Association.....	By Bernard J. Farrell	21
Many at Chicago Show.....	By L. A. Nixon	34
New Broadcasting Stations.....		62
Much Misunderstood Crystal Detector.....	By Claude Cathcart Levin	29
National Trade Survey of the Radio Industry.....	By John R. Hall	32
Noisy "B" Batteries and Why.....	By Walter B. Schulte	24
Out with the Fakers in the Radio Industry.....	By H. M. Konwiser	22
Radio Guild Makes "Set with Human Voice".....	By J. McKerchar	93
Radiolite, a New Phase in Radio.....	By Thomas J. Ryan	82
Retailers Should Really Advertise Now.....	By Eugene J. Scanlon	27
Summer Slump Benefits Radio Industry.....	By Alexander Eisemann	23
Trade-Mark Changes.....	By Chauncey P. Carter	59
Ways of Developing with Radio Industry.....	By William Guild	25

DEPARTMENTS

Advertising for Retail Dealer.....		39
Book Review.....	By Bernard J. Farrell	69
Editorial.....		30, 31
Trade-Mark Department.....	By Chauncey P. Carter	57
Milwaukee.....		58
Philadelphia Pointers.....	By W. B. Wilkinson	73
Radio Stocks.....	By Frank Stanton	71
What the Manufacturers Are Doing.....		56

THE RADIO DEALER, THE RADIO TRADE JOURNAL, published monthly at 1133 Broadway, New York, N. Y., by THE RADIO DEALER COMPANY, in the interest of dealers in Radio Supplies. HARRY M. KONWISER, Publisher; LAURENCE A. NIXON, Managing Editor; N. B. ZIMMERMAN, Editor; A. L. KONWISER, B.S., Technical Editor; Bernard J. Farrell and Eugene J. Scanlon, Associates; Jos. J. Ollendorf, Circulation Manager; John R. Hall, Research Manager.

REPRESENTATIVES IN THE TRADE: Elmer W. Moore, John R. Hall, H. E. Bennett, Wm. B. Wilkinson, Jr., J. M. Casper, J. A. Doucet, H. L. Krenz, M. A. Clark, C. L. Geesey, S. A. Frank, C. M. Minier, M. Jay Klein.

PUBLICATION OFFICE
1133 Broadway, New York, N. Y.
Telephone Watkins 8926-8927

PITTSBURGH
Suite 570, Union Arcade, Pittsburgh, Penna.

CENTRAL STATES
35 South Dearborn Street, Chicago, Ill.
Telephone Dearborn 4053

SOUTHERN STATES
730 Gravier Street, New Orleans, La.

PACIFIC COAST
Suite 910, 456 Spring Street, Los Angeles, Calif.

NEW JERSEY
845 Broad Street, Newark, N. J.
Telephone Market 4659

Advertising Rates and detailed statement of circulation and other information for advertisers furnished on application.
Circulation restricted to manufacturers, jobbers and retailers in wireless equipment. Subscription in the United States, one dollar the year, payable invariably in advance. Subscription in foreign countries, two dollars the year, payable invariably in advance.

Radio Equipment of the Highest Standard at Prices Made to Stimulate Summer Sales

EVERYTHING NEEDED TO STOCK YOUR STORE

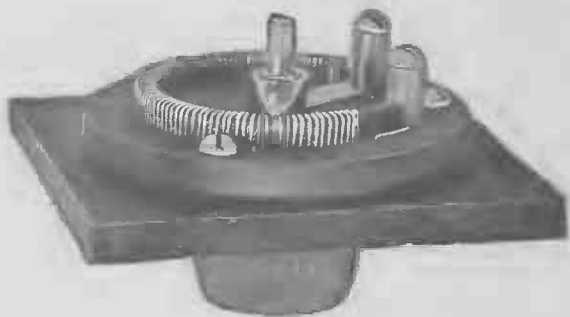

DRISCO RHEOSTAT

List.....80 Cents
The only rheostat on the market with resistor strip inserted *ENTIRELY* through base making cement or glue unnecessary and contact perfect at all times.

Other Specialties:

RADIOMETER
VARIOCOUPERS
HEADSETS
VERNIER RHEOSTATS
PHONE CONDENSERS
GRID CONDENSERS
SOCKETS
COMPLETE SETS

POTENTIOMETER
VARIOMETERS
DIALS
PLUGS
TUBES
SWITCH LEVERS
SPAGHETTI
ETC.

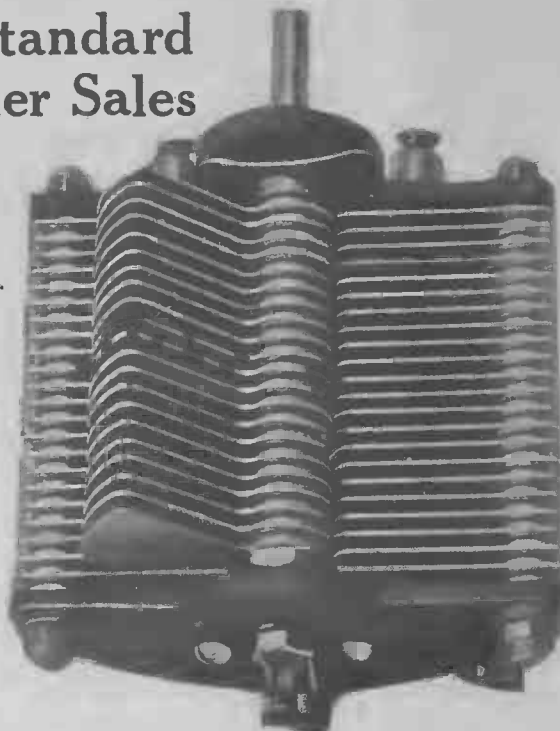

43 PLATE CONDENSER

List.....\$3.75
Equipped with Fahnestock Clips and wire ring washers giving perfect alignment between plates. Nickel finish throughout. Packed in individual boxes and furnished with stencil to aid mounting.

HAROLD M. SCHWAB, Inc.

Sole Distributor of Drisco Products

Write for Descriptive Catalogue

419 WEST 42nd STREET, NEW YORK CITY

Back Again!!

THE RADIO TELEGRAPHER

Established in 1917

Official Organ United Telegraphers' Association
The Only Paper for the Professional Radio Operator
Once Each Month. One Dollar the Year

Advertising Rates Upon Application

Published by

HARRY M. KONWISER

Publisher, The Radio Dealer

1133 Broadway

New York City

The Radio Dealer

THE RADIO TRADE JOURNAL

Edited and Published at

1133 Broadway, New York, N. Y.

FOR THE RADIO RETAILER

VOL. 1. NO. 5

AUGUST, 1922

ONE DOLLAR THE YEAR

Many Members for Radio Trade Association

National Membership Assured for Association Being Organized
For and By the Radio Trade

By BERNARD J. FARRELL

Associate Editor, The Radio Dealer

The response to the membership call issued by THE RADIO DEALER last month has brought in a large number of members for THE RADIO TRADE ASSOCIATION. Coming from almost every state in the Union these applications forecast a successful association and one that will have a national influence.

Carrying out its share of the organization work THE RADIO DEALER is proceeding with the formation of the association. Every bit of the work done to date by this publication has been without pay or without expectation of financial reimbursement. This is one of the ways that the publishers believe they can benefit the industry. And to further the association for the radio trade we invite the co-operation of all radio papers.

The Radio Trade Association will be of, for and by the trade. National officers will

be elected by the membership, a mail vote being planned for an early date. Every point of policy and every line of action for the association will be decided by the members of the association itself, without any snap decisions by any one member or small group of members.

The present plan, as suggested by this publication, calls for the employment of a paid secretary to manage the details of a national

headquarters. This secretary should be selected by the board of directors of the association at the first annual meeting of this board to be held at the first meeting of the association. Until this meeting can be arranged THE RADIO DEALER will furnish the secretarial work to the best of the ability of its editorial staff, who will serve without pay or compensation of any kind.

After the convention it will likely be con-
(Con't on page 74)

USE THIS COUPON TO JOIN

THE RADIO TRADE ASSOCIATION

THE RADIO DEALER,

1133 Broadway,
New York City.

Please count us in as charter members of

THE RADIO TRADE ASSOCIATION

and send us all bulletins regarding same as they are issued.

We are jobbers . . . , retailers . . . , manufacturers . . . of radio equipment.

Name

Town

State

Date

Out with the Fakers in the Radio Industry

How Every Man with Interests of Radio at Heart Can Help the Good Work Along

By HARRY M. KONWISER

"The profits in the manufacture of radio equipment run from 100 to 1,000 per cent. * * * The annual average of gross radio business since 1901 is \$50,000. * * * The sales for 1922 will amount to \$50,000,000. Radio securities are the opportunity of the day. * * * Millions have been made and are being made. * * * Men with visions who invested their small savings with Morse and with Bell are independent. * * * The same opportunity exists in radio."

These are but a few of the business opportunities offered via the radio stock route and THE RADIO DEALER takes the stand now that a genuine effort should be made by every honest

man in the radio industry to thwart the sale of fake radio stocks. Now is the time to strike—not after the public has been duped.

Newspapers and magazines as well as civic bodies should aid to suppress the promoters of fake radio stock. These fake stocks are in evidence everywhere and some of the fakers have even gone to the trouble of "establishing" factories and sales offices, making a pretense of selling to the trade.

Some of the fakers claim to have an abundance of orders. This cannot be the truth. Even the largest legitimate makers of radio apparatus and equipment have ample stocks and the cur-

rent demand is *not* in excess of production.

It is very difficult for the general public to differentiate between real, honest-to-goodness concerns making radio equipment and concerns established exclusively for stock jobbing purposes.

One wonders, properly, how some of the one room, combined office-factories do any volume of business. One wonders how up-one-flight manufacturers occupying 25 x 100 loft space can capitalize at \$100,000 and upward and sell stock.

A number of legitimate radio concerns are being floated via Wall Street, and some of the questionable
(Continued on page 66)

Wiggin Makes Pittsburgh Revolve Around Radio Fan

The success of the radio industry in Pittsburgh during the past year has been due largely to the energetic efforts of the radio amateurs, a body of men and boys to whom the present success of the radiophone is attributed. Although the members of this great body are not each and every one engineers in the science of radio, there are some who can safely claim this title, in view of the large amount of experimental work carried on by them. Among the most prominent of these is Parker E. Wiggin, Chief Engineer and Production Manager of The Radio Electric Company.

Mr. Wiggin received his early education in Kansas. Graduating from the Kansas City high school he entered the University of Kansas where he completed a course in electrical engineering. Mr. Wiggin became interested in radio as an amateur in 1907 and keeping step with the progressive development was soon recognized by amateurs all over the country as an authority on the subject. Entering the army April 9, 1917, this radio enthusiast served 18 months in the Radio Research Section of the United

States Signal Corps. At the signing of the armistice he entered the University of Toulouse, Toulouse, France, in which he spent 5 months in the study of electrical engineering passing the examinations for an E. E. degree.

Before leaving France he spent 5 months in the Sorbonne University, Paris, France, in the study of radio engineering. On his return to this country Mr. Wiggin entered the employ of the Westinghouse Electric and Manufacturing Company as a radio engineer, being one of the first radio engineers to work for this concern. His work here dealt largely with the designing of a broadcasting and commercial ship-and-shore apparatus.

Mr. Wiggin is a recognized member of the A. I. E. E., I. R. E., A. S. M. E. and R. E. S. P. In his capacity as a radio amateur he is rated as a first class commercial radio operator and now holds the position of city manager of the American Radio Relay League.

Mr. Wiggin's favorite subject is the antenna system, and he has delivered many noteworthy discourses on the subject throughout the country at amateur and engineering conventions.

He is particularly interested in giving out information and instructions to the new American radio amateur, and is devoting a small amount of his time in teaching radio in the Y. M. C. A. school in Pittsburgh. He is also one of the Radio Editors of two of Pittsburgh's leading newspapers.



PARKER E. WIGGIN
Radio Electric Co., Pittsburgh, Pa.

Summer Slump Benefits the Radio Industry

Taught Many Valuable Lessons to the Radio Trade at Large To Be Final Estimate

An exclusive interview with
ALEXANDER EISEMANN

Treasurer, Freed-Eisemann Radio Corporation

The slump in the radio business during the summer months is a boon to the industry. Both the dealers and the more stable and serious manufacturers have learned their lessons from radio's dull summer season.

What have the dealers and department stores learned? From my observations they have learned that it does not pay to carry some part of every line of apparatus that looks salable to them.

In other fields of industry it has been settled as a well established principle that the inventory of a department should contain the lines of a reasonable number of dependable manufacturers—not a heterogeneous lot of merchandise bought bit by bit from every Tom, Dick and Harry in the industry.

This principle has been found by some of our department store buyers to be particularly pertinent to radio purchasing because a stock cannot otherwise be kept clean and at the same time complete.

Of course the temporary scarcity some time ago was responsible for this helter skelter buying of everything that was offered for early delivery. Unfortunately some dealers are unable to obtain answers to their letters addressed to the manufacturers of the goods they have bought. Of course not; the manufacturers saw a chance to sell easily and profitably, and sold. When the demand stopped temporarily, they went out of business. Many have already closed shop, and when the unfortunate buyer writes to ask a question about the apparatus, the letter comes back as undelivered.

So buyers have learned that radio is no different than any other commodity. There is no ultimate satisfaction, no matter how cheap one buys, in stocking goods of any but financially responsible and dependable suppliers.

The art of radio is moving fast and manufacturers must watch their step to keep pace with the new developments. They no longer can stay in their offices and wait for buyers to come in, but must go after the buyers to sell. They must make good apparatus, for the day "to sell and not to use" merchandise is passed, and



ALEXANDER EISEMANN

is a well-known manufacturer of Radio instruments. He is the sworn enemy of the fakers who were attracted to the industry by the hopes of "easy money."

nothing counts as much as reputation for good and dependable apparatus. Outfits must be made to last, that is, they must be so built that the user will get permanent satisfaction and not find that his set has gone bad after using it a few weeks.

Radio is like everything else; if you buy a car and cannot get parts for it, you may as well use it for junk. Dealers have learned that clogging up their stocks with a lot of material bought from manufacturers who do not expect to stay in business after the radio craze is over, is a very poor policy. In New York the dealers want apparatus which any expert can tell at a glance whether the set can be sold.

Like every other industry, radio will result in the survival of the fittest. Those who put their reputations before their profits will survive, and

those who are handling business only to "cash in" on the wave of radio prosperity without regard for the reputation of their products, will soon be relegated in the limbo of things that were.

For this reason, the serious and more responsible manufacturers are watching the summer slump with satisfaction, knowing that the future good of the industry lies in the supplying of radio apparatus from dependable sources. Those who rushed into the business without regard to the quality of their wares and without regard to their positions in the patent situation are one by one leaving the field. There are plenty of reliable manufacturers in the business, and to them, for simple economic reasons, will gravitate the bulk of the business and the public will be the gainer.

Have You Ideas?

Patentable Inventions Should Not Be Discarded

By **ZOLTAN H. POLACHEK**

Consulting Engineer and Reg. Patent Attorney of the Mfrs. Patent Company

Practically every radio dealer and radio fan has, more or less, thought of some simple invention which, had it been worked out would have resulted in something of value. Many of the greatest and most useful inventions have been articles so simple that once they are in operation many people remark, "Well, anyone could have thought of that." To think of a good idea is only half the battle; to get it worked out and protected in the Patent Office is the next step.

Models are not required in the United States Patent Office for obtaining a patent. As soon as the idea of an invention is conceived, reliable firms of patent attorneys should be consulted. They will search the records of the United States Patent Office for a negligible fee and determine whether a similar invention has ever been patented before. If a patent has

(Continued on page 48)

Noisy "B" Batteries and Why

Explaining How and Why Properly Constructed Batteries Should Be Taken Care of

By WALTER B. SCHULTE
Secretary, Burgess Battery Company

In the July RADIO DEALER Mr. George G. Hyde calls attention to a characteristic of "B" Batteries which causes much annoyance and which often is confused with static. Mr. Hyde refers to "noisy" "B" Batteries and he relates his experience with them. It is indeed fortunate that an engineer of Mr. Hyde's reputation has taken this opportunity to explain the situation to the radio dealers. While it is true that "B" Batteries may produce phone noises which sound like static, these noises are not always due to poor batteries or old batteries. Other factors which the radio dealer controls can produce them.

The 'phone noises produced by "B" Batteries are the result, firstly, of poor radio construction in the batteries themselves, or secondly, of careless handling which the batteries receive after they leave the factory. While the readers of this magazine are more concerned with the handling and sale of batteries, a few words about their construction may be of interest.

Bloc "B" Batteries were developed during the war and practically all reliable batteries are now constructed in accordance to the specifications of the Army or the Navy. At the beginning of the "B" Battery development the manufacturers found it difficult to make noiseless batteries—they had been accustomed to assemble two or three flashlight cells with simple insulating materials, but they soon found that to assemble satisfactory "B" Batteries required more attention to detail and better materials of construction. The progressive manufacturers now understand the effects of "depolarization potentials" and "hydrogen over-voltage" on phone noises—they know also that moisture proofing is necessary and that dielectric as well as resistance losses take place in a "B" Battery and affect its final efficiency. There seems to be no reason now why the manufacturers, by following the best specifications, cannot make a noiseless battery.

The dealer has the battery delivered to him at an age of from one to two months. If the battery is correctly made by a reliable manufacturer and if it passes a voltage test which will

be mentioned later, at this age the battery is as good as new. Some radio engineers, in fact, prefer partly aged batteries which still continue to conform to the voltage specifications. It should be mentioned here that all "B" Batteries are tested by the manufacturers before shipment, and some manufacturers actually age the batteries two weeks to a month before testing them.

"B" Battery is extremely fragile. It is true that it appears solid and brick-like, but it must nevertheless be handled almost as carefully as a watch. The manufacturers ship batteries carefully packed in three-side corrugated cartons and the radio dealers must keep the batteries packed in these until they are sold. When batteries are sold with receiving sets, they should not be connected inside of the set, but should always be furnished separately in the cartons.

If a battery is dropped it will often be completely ruined because of the breakage of an inside connection. Sometimes this abuse does not appear serious. The damage, however, will appear later as phone noise, after the battery is put into operation.

A poorly constructed battery, that is, poorly constructed with reference to those characteristics of depolarization, insulation, moisture proofing, etc., will produce phone noises whether the battery is new or old, but it is likely to be noisier when partly discharged or aged. A battery made according to the best radio practice will not reduce phone noises even at extreme ages. This is known to be the fact as thousands of small aeroplane "B" Batteries, after standing almost two years, have been put into service without causing trouble from noises or lowered ampere-hour capacity.

Manufacturers usually rate a battery at a minimum hours of service at a definite discharge. Such rating is nominal and is usually exceeded in practice. Radio dealers may at times be called upon to explain why a battery did not stand up to the customer's expectations. Before committing himself or making replacements the

radio dealer should assure himself, that the rate of discharge was not exceeded by inquiring of the customer as to how many tubes were used and over what period of time. If possible the battery itself should be examined for marks and bruises which indicate handling or abuse by the customer before or during its installation in the receiving equipment.

A battery should always be tested before it is sold over the counter either by connecting it to a receiving set or a D.C. voltmeter. For testing the voltage a 0-25 or 0-50 volt scale instrument will be found convenient. An amperage test should never be used to test a "B" Battery.

The advertised rating of the usual bloc battery is 22.5 volts but as a matter of fact perfect batteries leave the factory testing from 21.5 to 22.0 volts. Radio dealers can be sure that any battery not showing handling abuse, and testing 22.0 volts is saleable and serviceable. This lower voltage is due to some of the chemical materials used in the manufacture of the batteries which give each of the fifteen cells a voltage of less than 1.5 volts. That this voltage is not an indication of a poor battery is evidenced by the fact that the Army specifications on small sizes call for a minimum of 21.5 volts. A "B" Battery is generally used to an end voltage of 17 volts, after which voltage the tube will not operate and 'phone noises may then develop, but these come from the tube as well as from the batteries.

A "B" Battery must never be placed in a window or showcase in direct sunlight. The intense heat under the glass may expand the air inside the battery and drive out some of the active elements and it may cause a bulging of the seal. It should be obvious also that the batteries must be kept in a dry place and the customer must be cautioned not to put them on a wet floor or in a damp room.

The radio dealer will keep his stock fresher by disposing of the batteries in rotation, always selling the oldest battery first.

(Continued on page 55)

Ways of Developing With the Radio Industry

Only One Way That Pays, However, and That Is By Establishing Reputation for Quality

By WILLIAM GUILD

Manager of Sales and Development, Radio Technical Laboratories, Newark, N. J.

Now that Radio has taken the first steps toward coming into its own as an integral part of the home life of the American people and the popular interest in broadcasting service has given birth almost overnight to a greatly multiplied and apparently insatiable demand for radio apparatus, the manufacturer has been confronted with problems of a character and magnitude entirely unexpected.

In the past the interest in amateur radio was confined to a comparatively small number of ingeniously inclined and pretty serious-minded folk whose needs were anticipated and provided for through certain well defined and rather limited channels who in turn depended upon a few of the old established and reliable manufacturers to supply them with the articles required and generally marketed under the trade mark of the dealer, not the manufacturer.

These manufacturers, working to the rigid specifications and high standards which have always been typical of the industry in the past, produced radio apparatus of the highest merit, both in material and workmanship, building up a reputation for reliability and dependability.

Apparatus of this kind produced in very limited quantities and so designed and constructed as to meet the exceedingly exacting requirements of the enthusiastic amateur of those days who knew what he should have and insisted upon getting it, naturally sold at a price commensurate with the high costs of producing it in such small quantities.

These apparently attractive prices, coupled with the tremendous demand which has arisen, have afforded an opportunity and a fertile field for the get-rich-quick and irresponsible manufacturer. This element, lacking pride in craftsmanship and utterly without the fundamental ethics of business, has flooded the market with inferior products (frequently exact copies externally of well-known types but of very doubtful operating value and even in some cases actually misbranded). They have sold to the jobbers, then to the retailers, and have capped the climax by direct-to-the-consumer mail order business in their



WILLIAM GUILD

recently returned from a Western tour and as a result is very enthusiastic concerning the future of Radio.

frenzied pursuit of the easy profits to be made by these methods but without regard to the injurious effects on the industry as a whole, which will be the naturally resulting reaction against such practices.

The old established jobbers unfortunately were not as alert to grasp the significance of the new movement on foot as some of their more active but less conscientious competitors have been, and in turn there has cropped up a veritable bevy of "jobbers of everything Radio" whose establishments consist of a desk-room, a telephone and a catalogue, and whose entire force consists of one man—themselves.

The same state of affairs has existed in the retail field and in any active radio section of the country may be found the most laughable and lamentable combinations of merchandise conceivable. Radio in drug stores, barber shops, clothing, stationery and notion stores and in one case noted by the writer even in a bootblack stand.

Proprietors of these stores in many cases absolutely ignorant of values and proper use of the apparatus and woefully lacking in even the simplest knowledge have been ordering merchandise promiscuously without the slightest regard for quality nor reliability nor for proper proportionment of the quantities of the various articles. Ordering and re-ordering from all comers in the hope that some one would supply them with goods to meet the insistent demands and in turn have been selling inferior merchandise to an ever gullible public without the slightest constructive work on their part and indeed in many cases due to the fact that most of these gentry are of the "always ready with a plausible answer" type have actually been most active disseminators of intentional misinformation.

Then along came the warm, attractive spring and summer evenings with daylight savings hours for leisure out-of-doors. The proprietor of the barber shop type of retail store noticed that he was no longer besieged by eager buyers of "anything radio," and he promptly canceled his orders placed with the jobbers of "anything radio," and stopped paying C. O. D. for packages which arrived, and either sent them back whence they came or kept them with an inner resolve to "let them wait for their money."

The jobbers of "anything radio" in turn began to sense that all was not as it should be, and many of them with slender resources and over expended commitments began to take stock of conditions and then came the deluge of cancelations against the back-yard manufacturers, many of whom now find themselves the owners of a large and overwhelming assortment of out-of-date apparatus which will surely cause some severe headaches before it is finally disposed of.

That is one side of the picture. Consider now the experience of the Radio Technical Laboratories, with which the writer is connected, which is typical of the right sort of manufacturer.

Early in the present movement those of us responsible for the policies of our company realized that for

(Continued on page 47)

Increased Interest To Be on Sounder Basis

An exclusive interview with

CHARLES H. LEHMAN

President, Dictograph Products Corp.

In the opinion of Mr. Lehman there will be an intensified and increased interest in radio in the coming fall, on a much sounder and more permanent basis than the excited and unintelligent distribution of the past few months.

Every manufacturer intending to stay in the business will naturally have to work out some problem for himself, but the basic problems are gradually being worked out. In the spring no one could foresee through just what channels ultimate distribution would take place. Almost every retailer with available store space looked toward this new industry as a possible means of making "quick" money.

This caused a number of mushroom jobbing and distributing houses to spring up as well, and while probably some of the exclusive radio jobbing and distributing houses will survive, it is Mr. Lehman's opinion that other than exclusive manufacturers' agents and exclusive distributors, the radio wholesaler and jobber will gradually die out or become a part of wholesaling or jobbing organizations handling kindred lines. Of course no one can forecast the whole future.

There are three particular channels through which ultimate distribution can take place.

First, through the small retail outlets and electrical supply stores, most of which will be handled by the wholesale and jobbing electrical supply houses, and possibly wholesale distributing houses in hardware and sporting goods lines.

The second ultimate source of distribution might be through the music trades, and the third through the large department stores.

Mr. Lehman feels that the manufacturer who picks the natural and legitimate channels and deals through reputable and responsible concerns is the one most likely to survive. As to discounts, he does not subscribe to the theory that the only difference between a jobber and a dealer is the quantities that they purchase.

The Dictograph Products Corporation holds that a small wholesaler is entitled to a larger discount than a large retailer. As manufacturers, this company does not sell any retail outlet

knowingly, referring all such inquiries to the jobbers.

The Dictograph Products Corporation has been large manufacturers of watch-case type receivers for many years, and has turned this experience to good account in producing radio products. The company is now producing over 750 radio head sets per day.

It has in preparation the Dictograph Radio Loud Speaker, which will be ready for distribution within the next few weeks, and Dictograph engineers are now engaged in perfecting a complete radio receiving set which will be up to the standard of excellence set by other Dictograph products. It is expected that this set will be available for distribution in the early fall.

The Dictograph Products Corporation has offices in every large city in America, in Europe and in the Orient, where several hundreds of thousands of deaf people use the "Acousticon." The "Acousticon" for the deaf is one of the company's best known products. Among other Dictograph products may be mentioned the Detective Dictograph, which has been used generally for the detection of crime, and the Dictograph System of Interior Telephones, used for intercommunication and for many other practical purposes.

Gets Fritz Medal

Marconi Honored by Engineering Societies

Senator Marconi was awarded the John Fritz medal on July 7, the highest honor in the gift of American engineers, and he also listened to the prediction by Professor Michael I. Pupin that the new science of radio would be so stimulated by the new electron tube, or radiotron, that within a few years a speech made in this city would be heard by wireless telephony on every spot on the globe where an aerial may be erected. Radio will girdle the globe like the sunlight, said other speakers, and as quickly.

The auditorium of the Engineering Societies Building was jammed with

engineers and on the platform sat forty leaders of the profession, including four who have received the same medal—Major Gen. George W. Goethals, builder of the Panama Canal; Orville Wright, who developed the airplane; Dr. Elihu Thomson, noted electrical engineer, and J. Waldo Smith, who directed the building of the last great link in the city's water supply system.

Marconi received a great ovation as he arose to receive the medal from Dr. Thomson, and even greater acclaim when he had finished his speech in which he thanked the engineers for the honor awarded to him "for the invention of wireless telegraphy."

"I have long realized that in America, more than anywhere else, the most cordial and generous encouragement is given to an honest endeavor to apply science to useful and practical purposes," said Senator Marconi. "I consider myself fortunate that much of my early work in radio has been carried out in this country, for I cannot help feeling that you realize that wireless communication has become useful, and often necessary, on land and sea, besides tending to increase and simplify the facilities for closer communications between distant people on this earth, thus contributing, I hope, to make good-will take the place of the unrest and mutual suspicion which, unfortunately, seems at present to be a dominating feeling amongst all nations."

Professor Pupin, himself an inventor of many wireless improvements, predicted that Marconi, now 48 years old, would himself add still more to the art of wireless, which, eventually, would girdle the globe.

Speaking of the new electron tubes, or radiotrons, which have been brought to a high stage of development by Dr. Irving Langmuir, Professor Pupin said that preparations were being rushed for wireless telephony over long distance and that there was not the slightest doubt that a successful system would be established soon. A set of these tubes is now being installed in the big new radio central station of the Radio Corporation of America at Port Jefferson, L. I.

"The vacuum tube oscillator is a new type of generator, the performance of which could not be even imitated by any other form of electrical generator," said Professor Pupin.

Professor Comfort A. Adams of Harvard University, chairman of the Medal Committee for the four great engineering societies, lauded Marconi as the man who had annihilated space, and urged the use of wireless for the promotion of peace.

Retailers Should Really Advertise Now

Don't Worry Too Much About Revolutionary Inventions, But Step Out Business-Like for Business

By EUGENE J. SCANLON of Morscan Radio Co.

Because radio operators, I mean fans, of course, are average human beings who work and because this is vacation time and the period of long days—this is the real time for live retailers to advertise.

Solicitors of advertising for newspapers, as well as trade papers, not to mention electrical trade papers and phonograph trade papers, have not sensed the fact that the "summer months" are the "good months" to sell radio apparatus.

Every person in the radio world must now sense the thought—the knowledge, if you please—that the Fall radio season will "be bigger and better than ever"; that with the return of folks to their city homes, from the seashore and mountain will come a real clarion cry for radio apparatus. And right—to get down to present activities; this is the time to experiment and if fans are urged to buy now and try now the results are bound to be pleasing.

Most of the daily newspapers "laid down" on this trade during the current warm weather. This proves only one thing—that the radio departments are improperly conducted; that, in the main, the radio editors are, possibly, familiar enough with radio itself, but have no business perspective.

There was no excuse this summer for predicting a slow up because of "static." Static, most of us know, is an overdone cry. It would have been better to have explained how to overcome "static" and, so the daily newspapers suffer criticism at the mouths of radio tradesmen and lose advertising business.

When the sun arrived at its northern destination on June 21st, the longest day in the year, it meant the reduction in strength of the sun rays and their too-much-talked-about effect upon wireless signals. Anyway these "static troubles" will daily be reduced and by the end of August the loud and the distant radio broadcasting stations will be available to everyone.

Get yourself "set" right now for some real business. It's to be had and don't worry too much about "new

revolutionary patents." That's mostly bunkum.

Certainly there will be new radio inventions, new contrivances to bring distant stations to the crystal set; new ideas to thwart all electrical disturbances; new processes for the tube set—but don't tell your customer the present apparatus is likely to be "junked" soon because of new inventions.

You can safely assure him that the new inventions will, in all probabilities, be made to be used in connection with any set he has or contemplates buying.

The cool Fall nights will be big nights for radio. I am told programs will be purchasable this Fall; that is certain broadcasting stations will sell their air performances to individuals. Don't ask me how; I cannot answer. I only repeat what I've been told—that high-class entertainment will be radiated from central stations on scrambled waves and listeners will be limited to those who lease "unmixer boxes," this innovation is promised for this Winter.

So, with all the radio talk we've had; with all the manufacturers and the jobbers and retailers—and urged by THE RADIO DEALER—all should be serene and profitable for retailers who start livening up their propositions.

It does not matter whether you are an electrical retailer and of the opin-

ion fostered by some of your jobbers that the radio business is yours by divine right; it does not matter if you are a phonograph dealer and have booths in your store; it does not matter if you are a hardware dealer or a druggist and it surely does not matter if you are a new born merchant, a radio retailer—it only matters that you must "step out" and go after all the radio business available.

The buyers of this next month and the other months realize the value of buying from "storekeepers." Too many, it is claimed, have been stung by mail order purchases. In most cases the "trouble" is their own because the mail order man cannot physically explain apparatus and equipment as can any retailer.

The Fall's business is coming to the retailer and the six thousand or more readers of this paper are urged to maintain their leadership in radio retailing by adapting proper business methods to assure them of the bulk of the trade that is about to be had.

Close to half million sets will be sold from August onward, until next Spring.

What are you, Mr. Reader, going to do to get some of this business? It'll total \$50,000,000.

Read what the stock promoters say about the possibilities—but don't buy their stocks. Stick to the profitable side by retailing radio in a business-like manner.

Maker of Auto Parts Has Remarkable Rise in Radio

By R. F. STAYMAN
Publicity Manager, Crosley Manufacturing Co.

Less than two years ago Powel Crosley, Jr., was in the automobile accessory business, and knew practically nothing about the wireless telephony industry. Today he is president and owner of the Crosley Manufacturing Company, one of the largest radio manufacturing concerns in the country, and is operating a business that is expanding so rapidly that even in his new plant he hardly has room to

handle the work that is piling up on him.

Mr. Crosley's entrance into the radio business was most interesting and what might be called spectacular. Less than two years ago his nine-year-old son decided that he wanted a radio set, and Mr. Crosley, like all good fathers, started out to try to fulfill his boy's request. Inquiries among Cincinnati dealers, then comparatively few in

(Continued on page 44)

Making Money in the Radio Business

What Does a Man Have to Know to be a Successful Radio Dealer? is Question Asked

By H. G. CISIN

(From THE RADIO TELEPHONE HANDBOOK)

The enormous demands for radio receiving sets has given rise to a rather peculiar condition insofar as the merchandising phases of the subject are concerned. Many merchants have been deterred from entering this highly profitable field because they have feared that radio is too technical a proposition for them. Others have been misled into employing radio amateurs able to speak knowingly about inductances, impedances and the like, but lacking a fundamental conception of the radio merchandising problem.

Now just what does a man have to know in order to sell radio apparatus intelligently—and successfully? Judging from the early demands one might almost be tempted to say—"nothing." However, although in numerous cases the unfit and untrained have been "getting away with it" and cashing in on the popular demand, the time will come when keen competition will weed out and eliminate these men from the radio business.

Getting back to the question of "how much" should be known and "how little" may be known, let us first analyze the type of customers who are in the market for radio apparatus. These may be divided roughly into three general classes. First and most important come the novices, then the amateurs and finally the technical enthusiasts.

The novices comprise that great portion of the public to whom radio is an entirely unfamiliar subject. They have read or heard about the marvelous radio telephone and they seek out the merchant to listen to the broadcasting, to gain information and then to buy a radio set. Eventually the novice becomes an amateur or "radio bug" and possibly he may even develop into a technical enthusiast.

The point to bear in mind when dealing with the novice is that the subject is probably entirely "Greek" to him. If he is met by a boy amateur who pours out a flood of words about reactive and inductive coupling, etc., he is apt to get the idea that the

subject is intricate and involved and to decide to put off purchasing a radio set until he has more time to study up on it.

The novice wants to know which set will give him the best results for the least money. He will notice that some radio sets are inexpensive, while others are very high in price. He wants to know why. The dealer must be able to tell him in a general way the difference between a crystal set and a vacuum tube set. The novice may have to put up an aerial. If he lives in a detached house his problem will differ from that of the man who lives in the average city dwelling or in an apartment house. He wants good practical information on the best way to string up the wire, on what height is necessary, on the proper length, on why insulators must be used. He wants to know about the "ground" connection. He is often worried about the license question and as to whether he must have electricity in his home in order to operate his set. He is interested in learning about the necessary adjustments of the set after it is installed.

None of these questions are of a highly technical nature. It stands to reason that the average citizen is not going to come into a store and ask for a definition of mutual inductance. He wants to buy a set with which he can amuse himself and his friends, and he wants to know which set to buy and how to get it and keep it in working condition. This information the dealer must be prepared to furnish. In addition, he must possess a general non-technical understanding of the basic principles of radio. He does not have to go into radio theory very deeply, but he is at a great advantage if he knows the ground work of the subject. The information contained in the first chapters of *The Radio Telephone Handbook* will enable a man to grasp the fundamentals of radio without confusing his mind with non-essentials. The dealer should also be familiar with the common radio terms. Of course he will gradually acquire a familiarity with

these words but at the start he should know enough about the subject to be able to name the parts of the various sets which he is trying to sell. As to answering the novice's questions, he should familiarize himself with the sets which he handles and should also know the aeriels necessary, etc. He can obtain a great deal of specific information about each set from the manufacturer of that particular set.

It is well for the dealer to handle sets of recognized merit. Before deciding to sell radio equipment he should get expert advice on this subject and stock sets which will give all-around satisfaction. This is an extremely important point, for if the merchant handles mediocre or poorly designed outfits, his trade is bound to dwindle and he will be the loser in the end.

Of enormous aid in getting sales is the installation of a demonstration outfit. Careful choice is again necessary in this case. If the set is complicated and requires delicate adjustment, prospective customers will be deterred from buying. As a case in point, a man who had practically decided to purchase an expensive radiophone outfit was compelled to wait nearly thirty minutes while the demonstrator turned various knobs, handles, etc., in an endeavor to get his set working. By the time the apparatus was tuned up, the would-be purchaser had decided to buy something simpler and less intricate. The next dealer he visited had a simple one-knob outfit. He turned the knob a few times and the music commenced to pour forth. The demonstration was simple and the sale was simple.

The loud speaker is often an important aid in demonstrating. It is its own advertiser. It can be placed at an open window and it has been proved to possess wonderful crowd-drawing ability. The listeners are nearly all potential buyers. If not for the more expensive sets, they may still be prospects for the cheaper sets. In this connection it should be noted that the man who buys a cheaper grade radio set eventually comes to the realization that the higher priced set will give him better results. Hence the radio sale is not neces-

(Continued on page 50)

The Much Misunderstood Crystal Detector

Tube Sets Only Lately Have Come Into Use Aboard Ship To Supplant Others

By **CLAUDE CATHCART LEVIN**
President, United Radio Telegraphers Association

The crystal detector is getting a lot of abuse that is entirely unwarranted in view of the merits of the type itself as a rectifier of radio signals. While it cannot be said that the crystal detector is as sensitive as the audion, nevertheless in a properly balanced circuit remarkable results can be obtained with the type.

It is only within the last two years that the audion or more properly, the vacuum tube detector, has become common on the high seas. To a great extent this was because of the patent litigation which, pending decision by the courts, has greatly hampered the development of the art. In fact today, many of the privately owned ships of the American Merchant Marine are only equipped with crystal detectors, although in many cases, the operators themselves, carry apparatus of their own for copying press and experimental purposes.

Why is it then that the average radio fan who has purchased a crystal set is unable to obtain even fair results except when he happens to be in the immediate vicinity of a broadcasting station. Some of the cause of the poor results is unfamiliarity with radio equipment but, in such simple affairs as crystal receivers are, this is negligible. The real cause of the dissatisfaction is the receivers now being sold on the market under the name of crystal sets are not properly constituted in their fundamental elements.

When the radio boom overwhelmed the country beginning last December, the stocks of the existing shops which had been catering to amateurs and experimenters for years were quickly cleaned out. The general public demand caught the trade entirely unprepared and the makers of standard reliable equipment were immediately swamped with such a volume of orders that they could give their attention to nothing else.

Radio apparatus of the vacuum tube type is as the reader knows, quite expensive and on the other hand crystal receivers can be made up very cheaply. In response to the tremendous demand, all kinds of apparatus began to make its appearance on the market. A number of makes of crystal receivers appeared in many cases



CLAUDE CATHCART LEVIN

President of the United Radio Telegraphers Association, editor of "The Radio Telegrapher" and author of several books for professional radio operators, is well qualified to speak on the subject discussed here.

During the war, Mr. Levin served in the Navy.

manufactured by people who had not even seen a radio set a few weeks previously.

It must be borne in mind that with the proper supporting values of inductance and capacity, which practically speaking means, couplers and condensers, crystal is reliable for use as a detector. The detector however sensitive is merely a rectifier, that is it must have the received signal brought to it in the circuit before it can perform its function. The vacuum tube detector itself will receive nothing unless placed in a properly balanced circuit. And certainly the same applies to the crystal. This is exactly what was lacking in these crystal sets which made their appearance on the boom market. Mostly they consisted of a coil of inductance, controlled by taps, perhaps a fixed condenser of doubtful value, the much abused crystal detector and of course a pair of phones. The circuit usually util-

ized was one abandoned in the very early days of radio telegraphy.

Made up to sell at \$15.00 or as much as can be extracted from the public, these sets go fast and do more to kill the enthusiasm of thousands of people in radio than all the other forces combined. Many of these sets were sold and are being sold under circumstances closely approaching a deliberate swindle. A demonstration set is rigged up out of sight consisting of a vacuum tube and amplifiers and the public is told the resultant received lectures or music as the case may be which fills the store is coming in on the "marvelous" set which is hooked up in plain view and which is as innocent of a received signal as a cow is of grand opera.

Given a good aerial, a variable coupler, inductive type, two condensers, one in the aerial and ground circuit and the other in the secondary circuit plus the other standard essentials and you have the elements of a receiver that is used in shipboard work today and giving satisfaction. All of these necessities can be incorporated in a receiver unit and sold for the price asked for these mockeries on the market today.

A great many people having had such sad results with the sets they have purchased are inclined to doubt the value of crystal as a reliable detector. Especially when they listen in on some friend's splendidly working vacuum tube receiver and compare the difference. These vacuum tube receivers however costing more money have been given more attention by their makers while the crystal has been neglected as described. Then again the nature of the vacuum tube called for more care in the very beginning. The logs of ships however show that remarkable and consistent work has been done with crystal in the receiving of signals.

Before the advent of the vacuum tube, it was customary to receive the time tick while lying in the harbor due to the uncertainty of always receiving it at sea and the few stations transmitting such signals. No difficulty was ever experienced in receiving the tick of Arlington while in the harbor of New York on a piece of

(Continued on page 42)

Editorial

Armstrong's New Ideas Not Business-Busting

The recent announcements made anent the Armstrong Super-Regenerator have caused a great deal of discussion among "fans" and many retailers and jobbers during the past few weeks, have been told the newest Armstrong development meant that present sets are soon to be discarded and that, therefore, present parts are likely to become unsalable.

Nothing of the sort is likely to happen.

Major Armstrong, in his lecture before the Radio Club of America, at Columbia University, explained the super-regenerative system and how it was bound to exert a big influence

upon the future developments—but that doesn't mean, really, that present sets and parts are scheduled to be sent to the scrap heap.

It is not expected that the Armstrong super-regenerator which employs a loop aerial, rheostats, storage batteries, and tubes will immediately revolutionize radio receiving. Radio engineers are now but starting out to study the new Armstrong ideas and from their labors will be developed loud-speaking sets free from distortion—provided all the connections and adjustments are properly made.

Meanwhile the folks in the trade can go right along selling crystal sets and tube sets and explaining their operations.

Let the future of radio take care of itself—today's activities mean profit to dealers and tomorrow's new things will do the same thing.

Make the Air Safe for Amusement

"In Radio as in all movements of a public nature evils are attached which if permitted to accumulate, always lessen the great value of that movement.

"Already in Radio telephone broadcasting, business men have seen the wonderful possibilities of advertising their products by Radio telephone and stations are contemplated with the idea of being operated especially for advertising service. These new companies plan to broadcast twenty-four hours a day, seven days in the week, permitting any retail store or mercantile firm to buy five or ten minutes time each day to advertise their products whether these be soup, shoes, furniture or flivvers.

"In order to keep Radio broadcasting on the high plane it should maintain in the eyes of the public, it must be handled as a sport. Radio is a sport today just as much as it was five and ten years ago when it was the big pastime for amateurs."

That's the opinion expressed by Francis F. Hamilton, Radio Editor of the "Indianapolis News" and part owner of WLK, the Indianapolis

broadcasting station favorably known to all Middle West fans.

Mr. Hamilton has kept his programs free of all advertisements and his opinion will be endorsed by the great majority of radio fans, who, after all, are the radio "customers" and must be pleased.

All real efforts to permit "air advertising" have been blocked by individual protests. Congress has heard from the folks back home (and THE RADIO DEALER) that present attempts to pervert the use of the air are not pleasing to radio folks and this paper, at this time, urges every retailer, jobber and manufacturer to protest in proper manner, lest the men interested in employing the air for advertising purposes get an upper hand in broadcasting.

It is possible for advertisers now to engage talent to entertain the ether hounds and they can be announced as "courtesy of John Jones Co."

That ought to suffice until such time as the folks who listen in can "tune out" and tap another wave length when advertising stunts are announced.

Talking Through Their Hat

Attention is directed to the numerous "editorial comments" prevalent in so-called theatrical papers anent the guilefulness of theatrical folks who lend themselves to radio broadcasting service.

It is said that several booking agencies will not permit their actors to participate in radio entertainments—without the consent of these employment agencies and it is declared that radio is damaging the theatres' attendance.

When the talking machine became a factor in the home, when the "movies" became popular and when open-air concerts were created the commercial minds of the theatrical world issued their vapid verbiage—predicting the elimination of the theatres.

Not all of us choose to believe that the theatre has been extinguished by the above referred to methods of entertainment and very few theatrical people believe radio's further advance will eliminate the entertainer.

What the commercial men of the theatre think is another thing, of course, and THE RADIO DEALER refuses to believe that the leeches of the theatrical art speak for the entertainers.

As broadcasting develops there will arise a demand for what is called "real entertainment" and when this demand is met the present vaudevillians will be in a new service—for they will be paid for their work.

Right now many vaudeville stars make phonograph records and do concert work and some of them make an effort to play in motion pictures. Can anyone say that these theatrical folks have injured themselves, their "booking agents" or their theatres by participating in these activities?

Will anyone say that Ed Wynn is less known or worth less money, as a theatrical attraction, because of his having performed for radio fans? Did Al Jolson injure his "rep" when he sang for radio users?

It is obvious that the "defenders" of the theatrical folks—self appointed, of course—are merely hopeful that their "stars" will eschew engaging in

radio work until the broadcasting folks have stepped up to the cashier's office and in this case that means the employment agency.

Theatrical paper maligning radio are merely "pulling the old Glory stuff." The "show business" is "in a bad way" but it's not yet due to the activities of radio. (It may be different in the future.)

No theatrical papers, serving the booking (employment) agents can interfere with radio. Nor can these mercenary one-way gentlemen prevent real artists from making their name famous all over the land and nothing can do it quicker than radio.

Can the artists reach a larger audience in a quicker manner than by radio?

It is obvious that radio will attract the stellar lights of the theatrical world more and more and as broadcasting develops the artists will be properly paid for their time.

Possibly the "theatrical press" is not aware of the fact that broadcasting is not a money-making process.

Do they know that a lot of money is spent each day to *give* the public free entertainment.

Naturally these mercenary-minded folks cannot conceive this fact. It is far from their conception of service to the public.

For the benefit of the unthinking it might be pertinent to make this statement:

When broadcasting activities are more properly developed the managers of the broadcasting stations will develop a scale of prices for entertainment rendered that will exceed that paid to the performer today by the booking agent.

Radio can withstand the officious dicta of the self-constituted protectors of theatrical artists, because these criticisms are, on their surface, not based upon facts,

Newspaper "Radio Departments"

The fan papers—particularly the daily newspapers in their so-called "radio departments"—feature stories on the building of low-priced sets.

They "show" their readers how receiving sets can be built for around three dollars.

And as for "parts" one would imagine manufacturers make 750 per cent. to judge from the cost of many parts—as indicated in these hurriedly prepared "radio departments."

At the same time these papers solicit advertising from manufacturers as well as jobbers and retailers and when "turned down" seem to enjoy printing more articles on how to build your own set.

The morons of the radio publishing field have their own set of rules and regulations.

But that's another story—to be told at some later date.

Much amusement develops from several newspaper articles recently brought to the attention of THE RADIO DEALER, claiming to show how to make a crystal detector.

Most of the devices simply use a twisted wire to make the contact with the crystal and then—all you need do is to find the sensitive spot.

They *never* tell you where to find the sensitive spot.

These are the things that annoy the "beginners"—the buyer who steps into a radio store and buys "per directions."

And further—about galena and crystals generally. Too many dealers fail to explain that one spot on the crystal when found should be continuously used. What's the difference where the spot? The result is all that can count.

Some retailers seem to fear to tell their patrons that a crystal can be broken up when found unsatisfactory and a new live spot developed.

Dealers should explain the easy method of mounting a crystal, after it is broken up. One example: Simply imbed the piece in a ball of tin foil

from a piece of chocolate and clamp the tin foil in the detector stand.

These little things make for friends and customers and that's what retailers must remember. Don't aim to sell a man once and then drop him.

Beginners should be educated to use a buzzer. That's elemental and will save a lot of annoyance. Put a buzzer on a crystal set and avoid a lot of criticism for the apparatus.

Right now the radio industry is an infant industry that must be nursed and nourished and selfish advertisers should not be permitted to despoil the pleasure of half a million set owners and their friends by using the air for advertising purposes.

THE RADIO DEALER believes that every one of the present radio associations, amateur and business, as well as scientific, should join in a proper protest to Congress against the use of the air for advertising purposes.

The future of radio is bound up in this and the commercial men of the trade, with their big money investments, must sense the danger that will develop from permitting Air advertising.

Let's all join in the protest. We'll gladly lead. Who will follow?

Not a Fad

Those who cry that Radio is only a "fad" are lacking in imagination.

They lack the power to visualize Radio as the greatest binding force in the world, soon to make every one on this giddy little globe "brothers and sisters under their skin."

Those who speak slightly of Radio do not realize, it seems, that this new Science has all the fascination of travel combined with all the comforts of home. The vista which Radio opens up of continents joined together by bonds that are invisible but stronger than steel is not to be denied.

Is Radio a "fad"? From the united and friendly world of the future the answer comes, "No!"

National Trade Survey of the Radio Industry

Radio Dealer Plans Research That Will Show Conditions in Industry in Every Section of The Country

By JOHN R. HALL

Research Editor, The Radio Dealer

As announced in THE RADIO DEALER WEEKLY of July 19th a national survey of the radio industry will be conducted by *The Service Bureau* of THE RADIO DEALER organization so that manufacturers in this field may properly direct their efforts toward developing trade.

This survey will secure the views of over a thousand leading makers of the various lines of wireless equipment sold by the readers of this publication, presenting them in compact form so as to show the consensus of opinion in general. No names will be mentioned in this portion of the survey, unless by especial permission of the manufacturers.

The second section of the survey will cover conditions among jobbers and retailers in the various sections of the country where radio equipment is sold. Over three hundred cities will be covered in this report. An attempt will be made to show what kind of equipment is most in demand with an estimate as to the number of retail outlets in each territory.

This combined analysis of the trade as a whole will serve as a valuable guide to the manufacturers interested, and will be presented to the trade as fast as the material can be gotten into compact form. Due to the mass of detail in connection with a research of this character it is not expected

that any of these reports will be available for publication before August 15th.

Information from firms who have conducted a local analysis will be appreciated, especial effort being made to reciprocate with information of value to those who aid in this investigation.

Figures as to the number of retail outlets in each section must not be considered final, as our investigators may be expected to err on the side of caution, but it is believed that this survey will be the first to present to the industry any approximately accurate estimate of the industry as a whole.

A Few Pointers to Remember in This New Business

By ADRIAN GOOD

Montclair Radio Mfg. Corporation

The whole fabric of a successful radio retail business is dependent upon careful consideration of the knowledge the layman has of radio, coupled with his desire to get consistent results out of a radio set. Keep in mind that diagrams, in nine cases out of ten, mean nothing to him. Ascertain, through diplomatic questioning, his regard for radio from the educational, musical, and topical value of the art. Interest him in the value of radio to his family, if he has one. If your customer should be a woman, appeal to her sense of value of the workmanship and finish of the set you desire to sell. Remember that a woman's pride in each household fixture is paramount to the obtaining of results. This does not mean that you should sacrifice efficiency of reception for a nicely finished cabinet.

Most dealers have an idea that all that is necessary to sell a radio set is to clap a pair of 'phones over the ears of a customer. If the customer does not bubble over with enthusiasm, or take the dealer in his arms, or plank down his money at once, the dealer blames the customer. The fact is, the day of rushing customers into sales without regard for their feelings or thoughts on the subject of radio, is

past. The dealer is probably not to blame in every case because he lacks knowledge of the fundamental theories of the art. Generally, it is because of causes beyond his control. If a transmitting station is poor it follows that the reception will be poor regardless of the quality of the receiving set. This leads me to say that there is no longer any excuse for any radio dealer excusing a poor demonstration by blaming a good broadcasting station. It is disgusting to hear a dealer dogmatically assure a customer that lectures and interesting bed-time stories are hurting radio.

Mr. Dealer, have you ever realized how important a factor your nearest broadcasting station is to the service you can render? Have you ever written the broadcasting station a letter of appreciation? Why does your customer buy a radio set? Certainly not because his neighbor has one. Not because it is the style. He makes his purchase based on a desire to either listen to educational discussions or musical concerts. Therefore, do everything that you can to show your appreciation of the inestimable value of the service rendered by your nearest broadcasting station.

The radio art depends upon science. The customer relies upon your knowledge of the science to initiate him into the art. A violation of the confidence of your customer is a violation of the sound ethics of business without which you cannot expect to be known as a real dealer selling real good merchandise.

If you do not know anything about radio, obtain the services of some one who does. It is more essential to spend a dollar, to please a customer, and make no profit than it is to make a dollar profit and lose a score of customers. Consider each person who enters your store, potentially a customer.

If you are sure that the public is tired of radio, put on your hat and walk around your neighborhood. Observe how few aerials there are in proportion to the number of residences. It took many years to sell the public phonographs. It will not take half the number of years to sell the entire populace radio. The point is: Are you prepared to serve your community?

Stop grumbling about static and vacations. Exert as much energy toward sales. Anticipate your needs and *order now* from the jobbers and distributors for future delivery. Radio sales will be unprecedented in the history of the art during September, October and November. December will see the S. R. O. sign before Christmas. The above statement is predicated upon a careful survey of the industry behind the art.



Announcing the Uradiola Line of De Luxe Radio Receivers

The General Radio Laboratories handle only tried and tested radio apparatus. Following this policy, we have adopted the URADIOLA line of DE LUXE radio receivers and are now offering to the dealer a line of apparatus which will move fast, bring in returns, and sell itself on its own merits (two models illustrated). In appearance, any URADIOLA model, from the URADIOGRAND to the series AI Tuner and Audion Detector, ranks among the finest in harmonizing with home appointments. The cabinet work is unexcelled.

A genuine hand-rubbed piano finish gives the instruments that touch which appeals to the particular buyer—the man who knows how to judge good furniture. For the man who knows radio, all that is necessary is to show him the inside. The buss-bar wiring, bakelite sockets, breakdown tested transformers and change-over inductance (for waves up to 10,000 meters) have been built into the apparatus by radio engineers of long standing. Waves up to 10,000 meters are received with this instrument, giving a broad range should the broadcasting wave lengths be increased. This is of untold value to the buyer. The manufacturers of the set state that the daylight range of the receivers is about 500 miles, while at night this is more than doubled.

Models not shown are AI Tuner and Audion Detector, Series C3; Tuner Audion Detector with Two-Step Amplifier, and Two-Step Amplifier alone.

We are also distributors for the super-sensitive Red Star radiophone head sets and Non-Leak variable condensers. Head sets come in 2000, 2400 and 3200 ohms resistances. Condensers are made in 14 plate, 22 plate, 44 plate and 64 plate sizes. Manufactured with or without vernier adjustment. These two pieces of "Quality Radio" apparatus are symbolical of our entire line and are fast sellers. Cool weather is coming, with long evenings indoors, when the demand for radio sets will again be beyond the capacity of the output.

Are you ready for
this demand?

Dealers and jobbers, write
for catalog, discounts and
information. We posi-
tively do not retail.



Red Star
Head Sets
2000—2400
—3200 Ohms

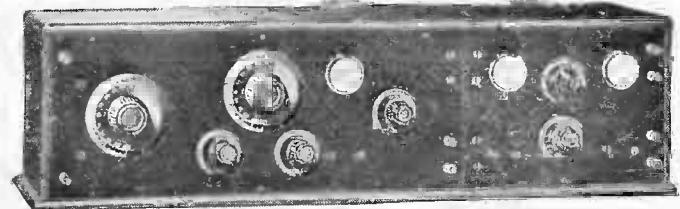
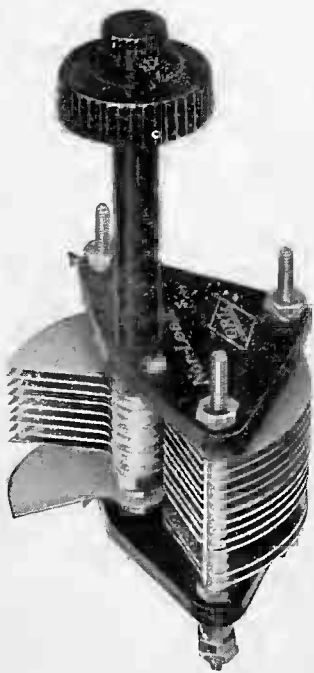

Series B2

1730 Tribune
Building

General Radio Laboratories
INCORPORATED

7 S. Dearborn
Street, Chicago

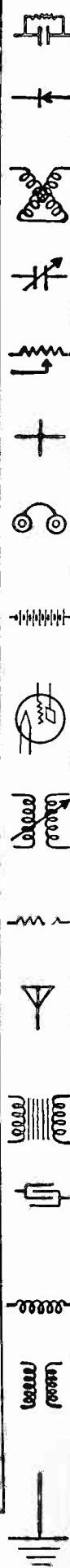
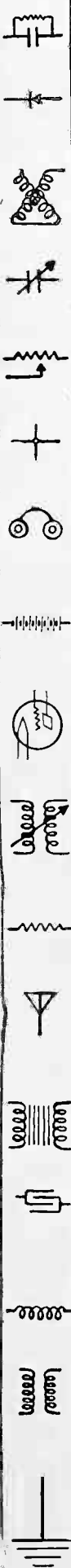

Many Exhibitors at National Exposition

Chicago Show Draws Trade from Wide Area to See Exhibits

By L. A. NIXON

The National Trade Exposition held at the Lieter Building, Chicago, June 26th to July 1st, inclusive, was one of the best attended shows ever held in this country. Visitors from all over the United States were in attendance.

Special meetings for jobbers, dealers and manufacturers were features of the show.

Manager Westbrook is to be congratulated on the show, and likely will find space for his second show to be held in January much in demand by the trade.

The following line-up of exhibits will give some idea of the show's offerings to the visiting dealers:

The Arex Radiophone Corporation of New York.

Agate Auto Appliance, Inc.

American Art Machine Company.

American Enamel Magnet Wire Company of Muskegon, Mich., was represented at the show with Thos. F. Kelly, factory representative and sales engineer in charge.

American Electric Co. exhibited their complete line, including American Electric headsets. The booth was in charge of P. C. Burns, president of the company, who was assisted by P. L. Rose and E. L. Brown of the company's radio staff.

American Radio Journal, booth in charge of F. George, Chicago representative, and J. A. Casey, publisher, assisted by Miss Madeline Stewart.

Ayan-Jay Sales Co., of Chicago, displaying their complete line of equipment.

The Ampli Radio Company displayed the Echo-Tone horn. Representatives of the company included Ralph Williams, president; E. W. Weist, J. T. Malloy and Earl Smith.

Beckley-Ralston Co., well-known Chicago distributors, displayed their line in an attractive booth, which was in charge of Mr. W. A. Bockius, A. N. Christianson, E. Eagleson and J. A. Sullivan.

The Benson Company, also of Chicago, displayed the "Bensonia," a cabinet

set of the most modern type. The company was represented by M. B. Benson, A. F. Haire, Jos. Lazar and Leo K. Kolisch.

The Board of Education had a number of attractive booths showing some of the handiwork of the pupils of the vocational departments of the public schools represented.

L. S. Brach Mfg. Co., Newark, N. J., manufacturers of the famous Brach Lightning Arrester, were represented by L. S. Brach, president; Stanley C. Bryant, Chicago manager, and W. R. Pfister, distributor.

The Bristol Company, showing the Audiphone horn, occupied a prominent booth, under the charge of M. J. Maguire, radio specialist, assisted by R. C. Wilcox and H. G. Hall, District Manager, of the Chicago Office.

The Chicago Radio Company displayed a complete line that includes novelties of considerable interest. Their booth was in charge of J. Frank Palmer, president; B. B. Barstook, E. Finston, D. B. Anglin and Miss Ruth Hartford.

The Citizens Radio Service Bureau was represented by Mr. R. H. Bell, displaying their 9th District Call Books.

The Coliseum Battery Company, of Chicago, showed their types of batteries for radio use, the booth being

managed by R. F. Harte, general sales manager.

The Commonwealth Edison Company occupied several large booths, their display being under the supervision of A. W. Inglis, D. H. Miller, Jr., E. R. Davis, J. Marshall, H. Randall and R. Werntz.

The Continental Radiophone Company booth was one of the most attractive in the show, being under the direction of Mr. Kinnelly, sales manager, assisted by O. G. Hinderer, engineer, and Wm. Sabetay, of the sales department.

The Coyne Trade and Engineering School exhibit had several working models in operation, attracting considerable attention, Mr. and Mrs. V. L. Richards occupying the exhibit.

The Crosley Mfg. Co. displayed their latest model, "New Cabinet Model 20," the booth being occupied by Powel Crosley, Jr., G. H. Robinson and F. O. Andridge.

The Cruver Manufacturing Company showed a display of Proudfoot products consisting of the latest design in detector amplifier units; also amplifying transformers, the latest design in audio-frequency transformers, and filament control jacks.

The automatic filament control detector two-stage amplifier attracted a great deal of attention on account of its compactness and absence of wires. Mr. A. R. Leland occupied the Exhibit.

The Darche Mfg. Co. displayed their complete line, E. Heilmann and P. W. Harman representing the company.

Dodge's School of Valparaiso, Ind., occupied a corner booth, the school being represented by Mr. and Mrs. P. G. Hardt and J. O. Hoskinson.

The W. O. Duntley Company, of Chicago, displayed the Duntley variable condenser with vernier adjustment, the booth being in charge of A. Fasking and S. W. Fasking, of the company.

The Davistone Com-
(Continued on page 84)



BOOTH OF THE WINKLER-REICHMANN AT THE CHICAGO RADIO SHOW

THE OLDEST, LARGEST EXCLUSIVE RADIO EQUIPMENT MANUFACTURERS ANNOUNCE A NEW TRADE NAME FOR THEIR LINE

Radak

Trademark Reg. U. S. Pat. Off.

RADIO has come to stay! And RADAK is going to hasten the process of stabilizing the radio equipment business.

The Clapp-Eastham Company has spent sixteen continuous years of exclusive radio specialization, working in the interests of radio professional and amateur alike. Now their experience and manufacturing skill are to be turned to the advantage of the dealer.

In announcing the adoption of the new trade name RADAK, Clapp-Eastham announce also the distribution of RADAK Receiving Sets and other radio equipment through jobbing distributors exclusively. These distributors will quote discounts to the dealer direct. And the new distribution plan enables the dealer to secure the maximum discount without quantity stipulation.

Advertising to a 25,000,000 Audience

The adoption of the new trade name RADAK gives the dealer an easily remembered, quickly identified line of merchandise for his store. To stimulate the process of identification, a new and more widespread advertising program has been entered upon. A consistent schedule on a yearly basis is under way in the following pub-

lications, reaching a receptive audience of well-to-do individuals in varied lines of occupation.

Saturday Evening Post.....	2,100,000	Copies
American Magazine	1,634,000	Copies
Farm Journal	1,012,000	Copies
Country Gentleman	829,000	Copies
Farm & Fireside.....	803,000	Copies
Successful Farming	862,000	Copies
Radio News	125,000	Copies
Wireless Age	45,000	Copies
Radio	60,000	Copies
Q. S. T.....	17,800	Copies

A very conservative estimate of four readers to the copy per magazine gives a total of well over 25 million people reached by this list.

Let's Get Together

RADAK spells opportunity. Opportunity for every wideawake dealer. Look into it. RADAK will soon become a household word. Make your store the RADAK headquarters. If you do not know the RADAK distributor in your locality, write us for the name and address.

CLAPP-EASTHAM COMPANY

America's Oldest, Largest Makers of Radio Equipment Exclusively, Established 1906

127 Main Street, Cambridge, Mass.

REGENERATIVE RECEIVING SETS AMPLIFIERS VARIOMETERS CONDENSERS
RHEOSTATS AMPLIFYING COILS UNIVERSAL TUBE SOCKETS
ELECTRO AMPLIPHONES

READ WHY CLAPP-EASTHAM EQUIPMENT SELLS. THESE ARE UNSOLICITED COMMENTS FROM RETAILERS

KEHLER RADIO LABORATORIES,
Abilene, Kansas.

"We have just recently been testing your improved regenerative sets and wish to state that we think they are a little wonder. For signal strength they are unexcelled by any of the highest priced sets on the market and are superior to some in this respect. They are also the least critical in tuning of any set which we have operated, as well as comparing favorably in selectivity. We are surprised at the absence of capacity effects from the body. We have a set in operation in our display department in the heart of Abilene, and with but two stages of audio-frequency amplification and a large magnavox, music and speech may be easily heard within a block of the horn which is

placed in the doorway. We have decided to specialize on this set, due to its reasonable price and its remarkable performance."

HOWARD S. BARLETT,
Knox, Pa.

"Am writing to you direct to compliment you on your Type H. R. Receiver and your Two-step Amplifier. They are the most wonderful receivers that there are on the market today. I have had them set up along with other standard makes that cost double and triple the price of yours, and will say that spark C. W. and voice come in over it more clear than with any of the rest. The only trouble that I find with them is to get them.

SEVER-BEACHAM RADIO COMPANY,
Santa Fe, New Mexico.

"Sometime ago we purchased one of your Type H. R. Regenerative Receivers and Two-stage Amplifier used in connection with a Magnavox. This outfit has brought in more stations and longer distance than any set we have handled. Everybody else in the surrounding country with more expensive outfits than ours are not getting results this time of the year, and we still hear the broadcasting stations as usual. We have heard Cleveland, Ohio, many times, which is about 2,000 miles, I should think. This was news and music, not wireless. We hear all the stations within a radius of 1,000 miles every night."

Advertising for the Retail Dealer

Dealer Should Avoid "Fear" Advertising

By JAMES WEIR
Publicity Engineer, Radio Electric Co.

In spite of the present slump in the radio business, due more or less to atmospheric conditions and vacation time, some dealers still insist on playing up the "fear propoganda" in their advertising, when both their time and money could be spent better and more profitably if directed in other channels.

The ad here displayed appeared in several Pittsburgh newspapers recently. What impression does it convey to you at first glance? The answer will undoubtedly be that "Radio is dangerous in the home."

If the radio dealer, jobber or manufacturer would stop but a moment to analyze the usefulness of the lightning arrester he would without doubt play a different tune on his "advertising horn." There is absolutely nothing devised yet that will wholly withstand a direct hit from lightning. Furthermore, unless a direct hit is made, the possibilities of fire are very small. Why not tell the real purpose of the lightning arrester, how it functions, and what advantages it affords the radio user.

The public does not have to be told that it is hazardous to operate radio telephone or line telephone equipment during a heavy storm. They know it

and common sense keeps them away from their instruments.

The June issue of a certain trade journal shows clearly the fallacy of this "hazard propoganda." In one instance they cite a number of cases each and every one a hazard, if that name is to be applied to radio installations. Metal gutters, down spouts, bath tubs, electric wiring, steel clothes-lines, telephone lines, trees, in fact anything of like nature is a potential aerial picking up to some degree the radio energy in the air. Why then do these not require lightning arresters to protect them?

It has been estimated that among 15,000 radio stations during the past ten years only two cases of direct hits by lightning were known. Conditions were not and have not been different. Storms come and go, lightning strikes people and buildings, yet strange to say none of these are equipped with radio installations.

The lightning arrester would not protect the home if lightning hit the aerial direct. You know it and I know it. What it does do, however, is to help make summer receptions a little more comfortable by conveying to the ground the accumulating atmospheric electricity which is in the air at all times.

Several years ago such propoganda as disclosed in the ad shown above might have been all right, but today even the underwriters have changed their minds and have come to the point where the rules and regulations set forth by them are not nearly so strict. What does this show? Merely that they realize that the necessity of big, clumsy ground switches and the like is past, and the "hazard" not nearly so bad as painted.

Protective devices nowadays are placed inside the house and instead of the heavy cable a small number 14 wire is all that is necessary for the ground lead. Today radio needs no more protection than your telephone or light lines, and needless to say the hazards are not any greater than those

already in the homes of millions of the American public.

I would like to see the dealers and manufacturers get together and do something in the way of relieving the fears of thousands who today would buy radio were it not for the fact that it has been declared "dangerous" by greenhorns in the game. Tell your customers the truth, even if your lightning arresters stay on the shelf till Christmas.

TIP TO DEALERS ON "B" BATTERIES

"B" batteries pass their usefulness after a few months and bring no satisfaction to the user.

Dealers, when purchasing "B" batteries should be sure they are of recent date—say, not over a few weeks old.

"B" batteries become unsatisfactory when standing idle any length of time, and if you are sure to buy fresh "B" batteries your customers will be satisfied and remain so.

So, beware the aged "B" battery.

RADIO OPERATORS' CONFAB

Claude C. Levin, president of the National United Radio Telegraphers' Association, and a committee of Radio Operators met with the representatives of the United States Shipping Board at New York recently to discuss the renewal of the agreement affecting wages and working conditions for Radio Operators at sea last week. It is understood that the present scales for cargo vessels will remain in effect, but an increase will probably be granted to the men on the larger vessels. The association has offices with the Ocean Association of Marine Engineers at 15 Whitehall Street, New York City.

Mr. Levin has been an untiring worker for the boys who operate on the seas and has helped develop better working conditions for sea operators. Mr. Levin is one of the editors of *The Radio Telegrapher*.

After LIGHTNING STRIKES and your HOUSE BURNS

It's too late to wish for a Lightning Arrester for your Radio Aerial. Law will likely compel its installation. We handle most any kind. Wire, phone or mail your order. Our automobile service makes all city deliveries.

Hear Newark, New York, Detroit and Washington. Our Receiving Set that sells for \$175.00 reaches most any point. None better at the price. If you heard them all, we believe you would buy our "King of the Radios." Write or phone us about it.

The Editor of the Retail Advertising Department of the RADIO DEALER will be glad to receive copies of advertisements that have successfully aided retailers in building up their business. Where personal criticism is desired stamped addressed envelope should be enclosed for reply.

A "Fear" Ad, calculated to scare thousands from Radio.

ACE



FALL BUSINESS

No. 115

A Special Type of Ace Wireless Battery for every "B" Circuit Requirement.

CUT THIS OUT
Return it to us for Special Information

(Check type battery interested in and approximate size order on which you want prices.)

To THE CARBON PRODUCTS CO.
LANCASTER, OHIO

Send us information on:

Type	List Price	Quote Prices	Quantity
315 Small Portable 22 1/2 volts	\$1.75		
115 Variable Type, 16 1/2-22 volts	3.00		
127 High Voltage, 18-40 1/2 volts	5.00		
172 Long Distance, 108 volts	15.00		

Send sample type No.

Name

Company

Street

City..... State.....

WHAT ARE YOU GOING TO SELL THIS FALL?

RADIO customers, you will find this fall, are going to be more particular about the supplies they buy. Last spring, radio was a rage—a fad—anything would do. Experience has put a more serious vein into the radio industry. Especially with "B" Batteries the customer must be particular to get what the ACE BATTERY offers, namely—

Elimination of disturbances. The Lock Nut terminals prohibit vibration.

All internal connections permanently secure. Extra heavy zinc used in cells . . . meaning longer life.

Interior layer of special composition directly under sealing compound, prevents bulging of seal due to escaping gases.

A Much Better Battery at a Conservative Price

THE CARBON PRODUCTS CO.

30 Years Experience in Manufacture of Batteries

LANCASTER,

OHIO

The Montclair Standard

The Aristocrat of Vacuum Tube Receiving Sets

Since 1909, the designers and engineer of this organization have been following closely the march of progress of Wireless Telephony and Telegraphy. Recently they decided to offer to the trade a compact, efficient, and aristocratic Receiving and Detector Unit in a single cabinet. It is, undoubtedly, the smallest Vacuum Tube Receiving Set manufactured for re-sale.



Much material and experimental work was required before we could give the public a Receiving Set that would be suitable for reasonable wave-ranges and distance, and still maintain loudness for which all seek.

The circuit is non-regenerative but of original and practical design. It increases Amplification without usual "Tube" noises or "frying," and without setting up oscillations which distort signals in telegraphy and the voice in telephony.

We are proud to offer to you the Montclair Standard.

From the Quartered Oak Cabinet to the special small Battery, every detail has been carefully observed; therefore we know that in placing this Receiving Set on the market we can unqualifiedly guarantee its performance as well as workmanship.

Montclair Radio Manufacturing Corporation

Sales Office: 657 BLOOMFIELD AVE., MONTCLAIR, N. J.

Adjustable Coil Mountings for Armstrong's Super-Regenerative Circuit



Single and Double Coil mountings adapted for use with the new Armstrong super-regenerative circuits. These mountings are adjustable. Made of genuine Formica, with high polish and fine finish. All metal parts heavily nickel plated. Not a moulded affair. **The Unbreakable Dial**

The New Triple Coil Mounting with the following features:

- 1—A patented feature; *locks* the coil in place. This prevents the coil from being thrown out of adjustment once the station is tuned in.
 - 2—The *simplest* mounting to install on your set. No rear mounting. Mounts on front of panel.
 - 3—The tension on specially constructed bearings is adjustable.
 - 4—Constructed of the highest *grade* of insulation material.
- Its high polish and fine finish give it a very attractive appearance. All metal parts heavily nickel plated. Not a moulded affair.

Triple Coil Mounting, List Price.....	\$5.00
Two Coil Mounting, List Price.....	3.50
Single Coil Mounting, List Price.....	.55
3" UNBREAKABLE Dial, List Price.....	.70
3½" UNBREAKABLE Dial, List Price....	.90
Ameco Radio Plug, List Price.....	1.00

Our production is large and your orders will receive immediate attention.

Jobbers write for special discount



ASTORLOID MFG. CO., INC.

416 Marcy Ave., Brooklyn

American Radio & Electric Co.

1133 BROADWAY

NEW YORK CITY



WRITE FOR OUR CATALOG
JUST OFF THE PRESS

**Advertising
for the Retailer**

Shall I tie up my advertising with that of the Federal Telephone and Telegraph Co? Is it good policy? —W., Illinois.

It is a good point to tie up retail advertising with nationally known goods and as the Federal company has such a good name you'd err in *not* taking advantage of the opportunity to explain, in your daily newspapers, and in your own catalog, that you are selling this line.

It's a standard line, made by big people. They're continuously spending money to create good will for their customers and you should profit by their work.

The average small town hasn't many retailers who advertise and the same holds good for big cities, because a retailer in a given section of any city can hardly expect to secure business from other parts of the city.

Still—it has been done and it's usually done on standard, advertised brands.

Please criticize the enclosed advertisements.—M., San Francisco.

The first advertisement reads: "Wireless Supplies—a large stock. Reliable goods. Reasonable prices. Advice free. Demonstrations all day."

Sensible and logical. The lay out shows the words "Wireless Supplies" in 24 point type, the other items in 14 point. All bold.

To repeat, a telling-it-to-them advertisement. Together with the name and address and trade-mark, the space occupied is eight inches, one column newspaper.

Not an expensive ad, but an ad that tells something.

"Complete Working Directions for the new radio marvel, the Armstrong Regenerative Set, amplifies sets 100,000 times. Hundreds of radio students stormed one of the Halls of Columbia to get a look at this circuit. You can have it for 25 cents."

Frankly, when the Armstrong invention became public—when the announcement was made—it seemed as if there would be any number of retailers who would arrange to have the "working directions" printed on a six by nine, four page folder, carrying the retailer's imprint on the front, and

**No Wireless Receiving
Set is complete without**



When you sell the Magnavox Radio, you cash in on the wonderful daily programs supplied by central broadcasting stations. The Magnavox Radio appeals not merely to the expert, but also to the average family. Push Magnavox Radio and you build new business for *all* radio supplies.

It is the Magnavox Radio which gives every receiving set its greatest enjoyment and use—doing away with the restrictions and limitations of the *individual headset*. The receiving set only *brings* the message, while Magnavox Radio *tells* it clearly and in full volume to all within reach of its voice.

R-2 Magnavox Radio with 18-inch horn: this instrument is intended for those who wish the utmost in amplifying power; for large audiences, dance halls, etc. \$85.00

R-3 Magnavox Radio with 14-inch horn: the ideal instrument for use in homes, offices, amateur stations, etc. \$45.00

Model C Magnavox Power Amplifier: insures getting

the largest possible power input for your Magnavox Radio.

AC-2-C, 2-Stage, \$80.00
AC-3-C, 3-Stage, 110.00

Write for name of nearest distributor and information as to how we help you *sell* Magnavox Radio.

The MAGNAVOX Co.
Oakland, California
New York: 370 Seventh Avenue

would offer to *give* the "directions" to any one applying.

Think of being the first in your town to give something away!

It's all right to try to sell, but service means advertising and giving away something is part of the service one would look for from up-to-date retailers.

Publishers are properly within their rights in trying to sell the Armstrong working directions but it's a good gamble for a retailer to give away these directions because the Armstrong announcement means that many fans will purchase the necessary parts.

And the dealer should angle for this business rather than for the profit from selling a set of plans.

What do you think of enclosed?—K., Newark.

Randel says: "If you can't get it here you can't get it in Newark. Radio supplies at less than wholesale."

A good adv., showing prices on standard apparatus, featured in sixteen inches, two columns, displayed on a par with department store advertising.

A good, readable ad and I'm sure it brought the Randel store results.

And, ho, ho, I notice Randel offers: "Free—descriptive plan of Armstrong's new hook-up."

VICTROLA ATTACHMENT

An attachment that permits the use of any Victrola as a Radio receiver is manufactured by the Bunting Stamp Company, Inc., 713 Liberty Street, Pittsburgh. This device consists of a pure molded bakelite disk with collar and a nickel-plated steel clamp which attaches to any singled head set on the market.

The Bunting Stamp Company also makes Vernier condensers, grid leaks, grid condensers and moulded dials. They have been in business since 1869.

SPIRAL ANTENNA

W. S. Krenz, of 339 South Centre Park Boulevard, Chicago, is placing on the market his K-N Helix Antenna, whose distinctive feature is that it is spirally wound. It is particularly designed for use in apartment houses.

Another outstanding feature of the K-N Antenna is that it is adjustable to any space and has a receptive area in all directions. It can be installed on the window case by means of two brackets. The manufacturer claims that the K-N Antenna thus satisfactorily solves the apartment house aerial problem.

U. S. Government May Lose German Wireless Patents

Francis P. Garvan, president of the Chemical Foundation, Inc., and former Custodian of Alien Property, is authority for the statement that if the government vacates the sale of German chemical patents a question will be raised as to the wireless patents and plans purchased by the United States Government.

Mr. Garvan is quoted, in the New York Times, as follows:

"The second question which has been continuously asked me is for what other sale in reference to patents will the Foundation case become a governing precedent. In answer thereto, first, sale of all wireless patents and plans to the United States Government for the nominal sum of \$140,000. Germany had obtained the domination in this country through a patent system similar to the chemical patent system, and to free the country from the control they were all sold to the Government for what, of course, is an inadequate price if you consider the value to Germany of the control of the wireless news of the world.

"Second, some 5,700 German patents were selected by the army and navy as having been taken out by the Germans to control our freedom in waging war. These patents covered gun sights and countless other appliances and devices either used by our army or navy or which might be used in the future. Many of them have been infringed upon by the army and navy in the winning of the war. The Alien Property Custodian turned over to the United States all the German rights and interests as between this Government and German interests to the navy for the nominal sum of \$100,000. This transaction will also have to be upset."

Garvan alleges that the war plotters found the transatlantic wireless station a sole means of overcoming the British control of the seas and of maintaining their touch with America, and from 1910 to 1914 there were begun and completed two high-powered wireless stations, one at Sayville and one at Tuckerton. The United States took control of the wireless stations when this country went to war. The Alien Property Custodian reported at the time that the Telefunken interests of Germany were back of the wireless plants, said Garvan.

The Telefunken system has been installed on many American coastwise vessels and has been operating with great success with the Sayville plant. From August, 1914, to March, 1917, the commercial use of the Sayville and Tuckerton stations was enormous, according to a government report, said Garvan. Then when war with the United States was imminent some of the Telefunken representatives in the Atlantic Communication Company organized a new company under the laws of New York and called it the New York Patent Exploitation Company. To this new company were transferred the three patent rights which belonged to the German interests.

The United States government paid \$140,000 for the two plants and this broke the German wireless monopoly when the plants entered into American control. Garvan maintains the German interests also seek to regain control of their patent rights in the wireless fields as they have already attempted to do in the Chemical industry.

This will mean that they will have ground to bring suits for damages on patent infringements. The amounts may run to \$1,000,000,000, Garvan alleges.

NEW PORTABLE SET

A complete portable radio set, which can readily and conveniently be used either in the woods or by the roadside by automobile parties, campers, boy scouts, etc., and out-of-doors in general, has been developed and is being marketed by the P. D. S. Sales Corporation, New York City. The "Ek-O" Portable Radio Set consists of a crystal detector set constructed in a solid weather-proof case, similar to a camera case, six inches square by four inches deep, with strap to sling over your shoulder. The set contains the necessary insulators for stringing the antenna, ground spike and wire, phone with head band, and a reel containing ninety feet of flexible antennæ wire. Complete instructions with each set show how to set it up and operate it. The set complete weighs about 3½ lbs., has a radius under favorable atmospheric conditions of 25 to 30 miles, and a wave length of 100 to 600 meters.

New Arrester

Electric Service Supplies Make the Keystone

A lightning arrester in which great attention to detail is displayed is manufactured by the Electric Service Supplies Co., of 17th and Cambria Streets, Philadelphia. They call it the Keystone Radio Lightning Arrester.

This safety device has many features of which its small size is an outstanding one. The Arrester can be installed in almost any location. It is weatherproof, thus enabling it to be installed out of doors, the logical place for an arrester. It is entirely enclosed and sealed, thus assuring that the internal parts cannot be misplaced and the efficiency of the arrester decreased thereby.

The makers claim that its use is superior to that of a lightning switch alone, because the radio operator is likely to forget to throw his switch to ground. The Keystone, on the other hand, needs no attention. Once it is installed it is always on guard and always grounded, ready to operate.

The Keystone is connected with line and ground leads. These are attached to metallic discharge plates within the arrester, separated by a very small air gap. These elements are enclosed in a porcelain housing which is thoroughly weather-proof, so that the arrester may be installed out of doors in any convenient location.

The Electric Service Supplies Company have been making lightning arresters for railway power and lightning circuits for thirty years. They also make a finished line of radio equipment.

ST. LOUIS SHOW IN OCT.

The St. Louis Radio Show will be held October 6th to 9th inclusive at the Coliseum, the largest hall that it is possible to obtain. This auditorium is well located and has excellent street car service from all sections of the city.

Owing to the fact that it was impossible to obtain use of the Coliseum before October 5th, the original date set for the opening of the show has been changed to the 6th, which will be only two days after the Veiled Prophet parade, and in the same week as originally planned. Two other conventions to be held in St. Louis will have their dates changed to make their gatherings simultaneous with the radio show.

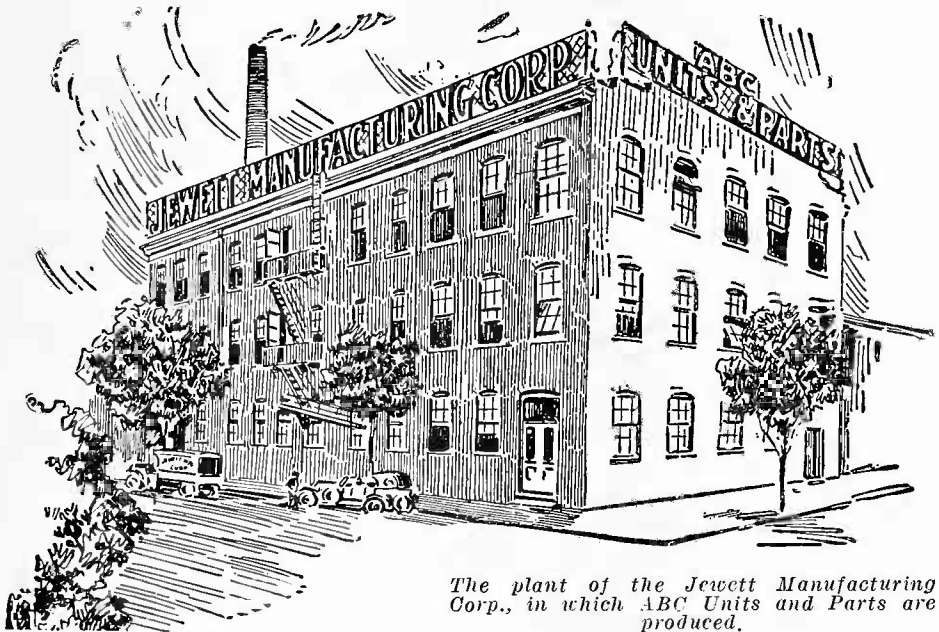

The plant of the Jewett Manufacturing Corp., in which ABC Units and Parts are produced.

ABC Parts for Radio Receiving Sets



A supply of this attractive Catalog, imprinted with dealer's name and address, will be furnished to dealers who carry ABC radio products.

THE plant of the Jewett Manufacturing Corporation is among the very few well equipped factories devoted exclusively to the manufacture of radio products.

Every radio dealer should send for our new Catalog "Parts for a Radio Receiving Set"—listing the correctly designed, carefully produced and attractively finished products bearing the trade mark ABC.

JEWETT MANUFACTURING CORP.

342 Madison Avenue, Dept. F8
NEW YORK CITY

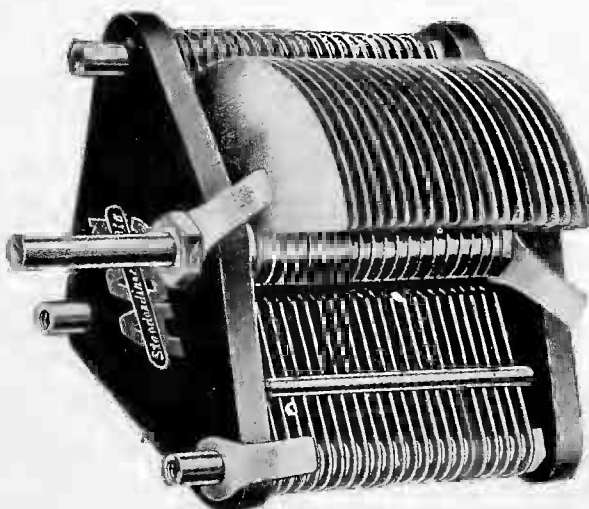

43 Plate 1/2 Size

ABC Variable Plate Condenser

Made in our own factory, which is equipped to produce radio units and parts of the highest quality.

No.	Max. Capacity Approximate	List Price
650-43	.0011 M. F.	\$5.00
650-21	.00055 M. F.	3.75
650-11	.00028 M. F.	3.00
650- 3	.0001 M. F.	2.25

Transmitting Condensers (For sets up to 1500 Volts)

	Approximate	
650-43-C. W.	.00043 M. F.	\$9.75
650-21-C. W.	.00025 M. F.	6.00
(Prices do not include Dial Unit)		
675 ABC Dial (3 in. dia., 1/4 in. shaft)		0.75

A NEW BOOK FOR EXPERIMENTERS!

ELEMENTARY TEXT-BOOK ON WIRELESS VACUUM TUBES

3rd Edition

by **JOHN SCOTT-TAGGART**

Member of the American Institute of Electrical Engineers
WRITTEN EXPRESSLY FOR THE AMERICAN AMATEUR

230 Pages. 130 real practical circuits. The best book on C. W. and Telephony. Handsomely bound in blue art vellum.

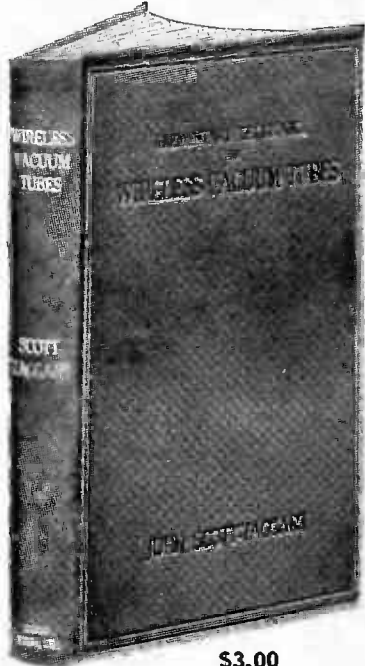

\$3.00

Extraordinary Sales

Dealers are invited to send orders for 12 or more copies on special terms.

JOHN FIRTH COMPANY, 709 Sixth Ave., N. Y.

Abused Crystal Set

(Continued from page 29)

crystal in the daytime. Amplifiers in connection with ships work were practically unknown. On the transatlantic run, the time tick was received almost to the half way mark and stations on the Florida coast were frequently heard. It was no uncommon thing for ships on the Pacific to be heard by ships on the Atlantic and there is a case of a ship 195 miles east of Japan being heard by a station at Boston.

The transatlantic liners regularly received press all the way across, it being broadcasted by a station located at Cape Cod and from Arlington then as now. When these stations were dropped MPD, Poldhu, Lands End, England, was picked up and it was not at all unusual for both stations to be heard together for one or two nights. Then again the ships on the regular run were usually in touch with Cape Race, VCE, and Crookhaven, Ireland, GCK, at the same time when in the middle.

On the offshore run some remarkable work was done between the ships plying between North and South America and the American coastal stations were heard with great regularity by ships in tropical waters and frequent communication was established. I say "was" in speaking of these generalities because I am speaking of the days when the crystal detector was used exclusively for ship to shore work. Today with vacuum tube detectors and in cases with radio as well as audion frequency being used, the same work and better is being done but with this equipment it is taken for granted that it should be and causes no comment.

On the American ships carborundum was the mineral principally used with a regulated dry battery current flowing across it. Usually the operators carried a few pieces of galena with them which were hooked up when outside with a great air of secrecy. Carborundum while extremely reliable is not sensitive to the extent of galena. Galena, however, requires a very fine adjustment of the cat whisker which must rest lightly on one of the sensitive spots of the mineral. A slight jar or loud signals transmitted from a station close by are very apt to throw it out of adjustment. The writer has however used a piece for days and days at a time on a voyage to South America without adjustment after the first time, but this is the exception rather than the rule. For receiving purposes alone.

TUNING COILS

Cross Weave Tuning Coils the heart of a receiving set just the coils for bringing in the Radiophone Broadcasting stations 180-500 Meters. Price \$1.25 each, or set of three coils Primary, Secondary and Ticker Coils, \$3.50 per set with circuit diagram.

CONDENSERS

Phone and Grid built of the best material obtainable. Price \$1.00 each.

MOTOR-GENERATOR SET

250 Volt DC 175 Watt Generator and 110 Volt AC 60 Cycle (Any Cycle) Motor. The best there is. Price \$78.00 complete.

AERIPHONE

The wireless telephones. Price \$35.00 to \$300.00.

PANELS

Treated with a special process made by us. Will not Warp or Shrink and is not affected by Temperature changes. Waterproof and possesses High Dielectric properties. Easily machined and will not Crack or BREAK. Looks as good as Bakelite. We are prepared to ship promptly the following sizes:

6" x 6"	x 1/4" thick	\$.60
6" x 7"	x 1/4" thick75
6" x 10 1/2"	x 1/4" thick	1.00
6" x 12"	x 1/4" thick	1.25
9" x 12"	x 1/4" thick	1.50
9" x 14"	x 1/4" thick	1.75
12" x 14"	x 1/4" thick	2.20
12" x 21"	x 1/4" thick	3.00

Strips 3 1/2 x 6; 3 1/2 x 8, \$.40 each; 3 1/2 x 10, 3 1/2 x 12, \$.60 each; 3 1/2 x 18, \$.75 each.

Add postage for 1 lb. for Panels up to 6 x 12 x 1/4; and 2 lbs. for larger sizes.

We will be pleased to quote prices on these panels cut to a different size on receipt of your specifications. NO FREE SAMPLES.

NATIONAL RADIO CO.
MARSHALL, MINN.

Variable Condensers

SEMI-CIRCULAR TYPE

	List
43 Plate.....	\$3.75
23 Plate.....	3.00
11 Plate.....	2.75
3 Plate.....	1.25

BALANCE TYPE

.001 Mfd.....	\$5.50
.0005 Mfd.....	4.75
.0025 Mfd.....	4.00

SQUARE LAW TYPE

.0015 Mfd.....	\$6.50
.001 Mfd.....	5.50
.00075 Mfd.....	4.50
.0005 Mfd.....	3.50

Montrose Mfg. Co.

1200 Bedford Ave. Brooklyn, N. Y.

THE KENTONE RADIO AMPLIFYING HORN



Made of brass, highly polished and nickel plated. Fifteen inches high, six inch bell

RETAILS FOR \$6.00

Write for particulars

F. C. KENT CO.

IRVINGTON

NEW JERSEY

galena should be ideal as the most frequent cause of its needing adjustment is due to its being thrown out by the forced oscillations of the transmitting station such as on board ship where both are done.

The tuners used in connection with the distance work described were not elaborate affairs. They consisted fundamentally of the elements mentioned and could be tuned up to 3,000 meters as a rule. A great many of them are still in service with in some cases the additions of switches for changing to vacuum tube reception.

Thus with the proper elements there is no reason why good reception should not be obtained using crystal as a rectifier. Considering the monstrosities that are masquerading as crystal detector sets, it is advisable for the average person to buy the few parts needed and assemble the set. The circuits used are fundamental and extremely simple and the parts are even on the boom market, cheap. The results obtained will be sure to satisfy and the full benefits of broadcasting obtained at a small outlay of time and money.

TESTING UNITS FIRM

Specializing in testing and fault-finding apparatus, the Queen-Gray Company, Philadelphia, are among the leaders in their field. Leading off with their Queen Dial Decade Set for resistance and insulation measurements and the location of crosses and grounds, their line includes galvanometers, ohmmeters, fault finders, farad meters, etc.

These instruments were evolved in other electrical fields long before Radio achieved its present prominence. When Radio found the need for instruments to discover grounds, crosses to test resistances, capacity and the like, the Queen-Gray Company were ready to answer that need.

The company takes pride in adhering to three ideals in the construction of testing instruments, accuracy, wide range of measurement and permanency.

SUCCESSFUL COAST SHOW

The first but most complete Radio Exposition ever conducted on the Pacific Coast closed recently at the Emporium, San Francisco. It was very successful, as all available space was taken shortly after the first announcement was made public, and the display of radio instruments was from the world's largest and most famous manufacturers. Among the exhibits creating unusual interest were those presented by the Federal Telephone and Telegraph Company, and the Radio Electric Co. of Pittsburgh.

HERE'S REAL RADIO SERVICE!

THE Radio Supplies you want WHEN YOU WANT THEM! IMMEDIATE DELIVERIES our motto.

The most comprehensive stock of Radio supplies in America. Get into it right, to make your success in the Radio field brighter and easier!

Complete lines of A. B. C., Lyradion, Pennsylvania Wireless Regenerative Receivers, Atwater Kent, Penn Radio, Bel-Echo, Electro Mfg. Co., Homecharger, Continental Fibre Co., General Apparatus, etc., etc.

G. A. One Stage Amplifier, Laboratory Type
A. B. C. Two Stage Amplifier No. 5014
G. A. Three Stage Radio Frequency Amplifier
Lightning Arresters (Brach)
A. B. C. 27 Volt Battery
No. 1—Insulated Binding Post
No. 2—Insulated Binding Post
No. 3—Nicked Brass Binding Posts
No. 4—Nicked Brass Binding Posts
COILS, HONEYCOMB A. B. C.
Mounted B. L. No. 25 to 1250
National Moulded Phone Condenser .003 MFD.
No. 650—3 Variable Condenser A. B. C.
No. 650—11 Variable Condenser A. B. C.
No. 650—21 Variable Condenser A. B. C.
No. 650—43 Variable Condenser A. B. C.
No. 800 A. B. C. Three Capacity Grid Condenser
No. 1 G. Grid Condenser
No. 2 G. L. Grid Leak Condenser
No. 3 P. Phone Condenser
Mounted Galena Crystals
Mounted Goldite Crystals
Unmounted Galena Crystals
Unmounted Goldite Crystals
1/4" x 1/4" Contacts and Nuts No. 56
1/4" x 3/8" Contacts and Nuts No. 57
1/4" x 3/16" Contacts and Nuts No. 58
3/16" x 3/16" Contacts and Nuts No. 59
3/16" x 1/8" Contacts and Nuts No. 60
Fidelity Crystal Detector
G. A. Laboratory Type Detector
A. B. C. Detector and 1 Stage Amplifier No. 5013
G. A. Laboratory Detector and 2 Stage Amplifier
G. A. Detector and 2 Stage Semi-Finish
3" Electro Dial 1/4" Shaft No. 506
3" No. 670 A. B. C. Metal Dial
4" Electro Dial 1/4" Shaft No. 508
3" Moulded Dial 3/16" Shaft No. 510
3 3/8" Moulded Dial 1/4" Shaft No. 514
3" German Silver Dial 3/16" Shaft No. 516
3" German Silver Dial 1/4" Shaft No. 518
Homecharger No. 5144 C
Ball Insulators No. 4500 Electro
Baby Insulators No. 4501 Electro
7" Insulators No. 4507 Electro

Jensen Single Circuit Jack No. 350
Jensen Closed Circuit Jack No. 351
Jensen Double Circuit Jack No. 352
Jensen Single Circuit Filament Control No. 353
Jensen Double Circuit Filament Control No. 354
A. B. C. No. 5005 Loud Speaker
No. 753 Two Coil Mounting A. B. C.
No. 754 Three Coil Mounting A. B. C.
Bakelite Panels
3/16 x 6 x 8 Smooth edged
3/16 x 6 x 12 Smooth edged
3/16 x 6 x 16 Smooth edged
3/16 x 12 x 18 Smooth edged
Jensen Round Plug
No. 5010 A. B. C. Crystal Receiver
G. A. 150-600 Semi-Finish Receiver
G. A. 150-2600 Semi-Finish Receiver
Tuska No. 224 Receiver
A. B. C. Rheostat No. 1125
G. A. Rheostat
Slider Rods 3/16 x 3/16 x 8"
Slider Rods 3/16 x 3/16 x 10"
Slider Rods 1/4 x 1/4 x 8"
Slider Rods 1/4 x 1/4 x 10"
3/16" Brass Sliders No. 875
1/4" Brass Sliders No. 876
V. T. Single Sockets
V. T. Double Sockets
National Moulded Socket
Switch Stops Nicked No. 975
Rotary Switches 1 3/8" No. 95 (National)
Anti-Capacity Switch Jensen
Firclo-Clad Amplifier Transformer
G. A. Radio Frequency Transformer
Bel-Echo Telephones 2200 Ohms
Party Phone
Cambic Tubing No. 14
Atwater Kent Variometer
Atwater Kent Variocoupler
A. P. Detector Tubes
A. P. Amplifier Tubes
No. 14 Solid Copper Wire 100 ft. Coil
7-22 Stranded Copper Wire 100 ft. Coil
7-22 Tinned Copper Wire 100 ft. Coil

Dealers, Write or Wire Today for Catalog 101A

Pittsburgh Radio Supply House

BELL TELEPHONE, GRANT 3632

963 LIBERTY AVENUE

PITTSBURGH, PA.

Telephones: 5454 Beekman 2787

NAME PLATE COMPANY
ETCHED OR LITHOGRAPHED METAL
NAME PLATES, SIGNS, DIALS
125 FULTON ST., NEW YORK



Our Radio Department is conducted by electrical engineers which assures you with dependable and highly efficient Radio equipment, either in complete sets or separate units, such as Head Receivers, Varicouplers, Variometer, Cabinets, Detectors, Antennas, Rotary Spark Gaps, Sliders, Panels, Dials, Knobs, Condensers, Grid Leaks, Contacts, Galena Crystals, etc.

For a popular home receiving set we recommend the **RESODON**. This set comes in a beautiful mahogany finished cabinet. Write for literature.

PAUL G. NIEHOFF & CO., Inc.
Electrical Laboratories and Manufacturers
238 E. Ohio Street Chicago

WANTED

Jobbers and Distributors

We are manufacturing a Combination Rheostat-Audion Bulb Socket easily fastened inside to the panel, including neat controlling Rheostat knob. All furnished as one Unit. List price, \$2.20.

We will also furnish prices and photos on our latest type of Skeleton Variometers on Moulded Base, and Receiving Sets selling from \$5 up.

Ajax Radio Corporation
536 So. 10th Street
NEWARK, N. J.

Remarkable Rise

(Continued from page 27)

number, revealed the fact that too large an investment would be necessary for so young a child, and he returned home with the sad news for his youngster. But during the next several days Mr. Crosley did no small amount of thinking, and finally came to the decision that he could make a set for his son at a cost much less than that demanded by the dealers he had visited. He then was operating a factory in which wooden articles were made, as well as handling his automobile business, and he decided that the woodworking plant would be a good place to make the receiving set. The results were astonishing, and with them came the idea of entering the radio manufacturing field.

One step followed another in quick succession, and within a few months he had perfected and was turning out several models of receivers as efficient as any on the market and at a cost much lower. Crystal sets were made first, then came the audion detector, the two-step amplifier and others, Mr. Crosley making almost all the parts used in his completed units. The improvements of his parts over others on the market soon brought a heavy demand for them, and through a combination of advertising and producing efficient instruments, Mr. Crosley rapidly arose from a novice to one of the leading radio manufacturers of the United States.

Chief among the parts he manufactures is the Crosley Variable Condenser, which has many advantages over the interlocking plate air condensers, and rapidly is working its way into the hearts of thousands and thousands of radio enthusiasts. With the increase of business came the idea of installing a broadcasting station, and this immediately was carried into effect. The station has been heard in the New England states, Montana, Oklahoma, Texas and other far distant states, and it is safe to say that it has a range of 1,500 miles.

This broadcasting plant is in use today, and the programs, news bulletins and addresses being sent from it are bringing thousands of letters of appreciation from persons who "listen in" during the three nights a week allotted to the company. But soon this station is to be replaced by one with a broadcasting power much greater, in fact one that will compete with the most powerful in the country, and then, with the steady increase in his business, the ambition that came to Mr. Crosley with his son's request for a radio set will have been fulfilled.

DEALERS

Send for free samples of our **WINDOW DISPLAY SIGNS AND CARTOONS** featuring **RADIO EQUIPMENT**.

THEY ARE REAL RESULT GETTERS

Merchant's Sign Service
48 Zabriskie St. Jersey City, N. J.



Echophone Loud Speaker Sets

IMMEDIATE DELIVERY

Discounts to jobbers and dealers
AERIAL WIRE.

19 strand tinned silicon bronze
VARIABLE CONDENSERS

11-21-23-43 Plate

EISEMANN HEAD PHONES

Super-sensitive

Variometers Variocouplers
Binding Posts Contact Points

General Auto Electric Co.

231 Halsey St.

Newark New Jersey

Manufacturing Possibilities

Screw Machines—Lathes—Punch Presses — Winding Equipment, Etc. — All Available for the Manufacture of

RADIO APPARATUS

and

RADIO ACCESSORIES

Submit Blue Prints or Specifications for Estimates

We Can Manufacture It for You

STEEL PRODUCTS MFG. CO.

4613 Roosevelt Road
Chicago, Ill.

New Western Office

C. L. Geesey Moves to Larger Chicago Quarters

With a view to developing more largely and giving better service to the Middle West subscribers and advertisers in the radio field, C. L. Geesey, for many years, engaged in the publishing and advertising business in Chicago, has been secured to represent THE RADIO DEALER in that territory, with headquarters at 35 South Dearborn Street, Room 605, Crilly Building, and the title of Western Representative.

Mr. Geesey is especially familiar with trade publication work and during the past ten years has devoted much of his attention to the editing, publishing and business management of trade papers. He also for a considerable time has been connected with a direct-by-mail advertising business, equipped with its own printing plant and other allied industries. He has a thorough understanding of every detail of advertising routine—a specialized knowledge that is at the disposal of members of the advertising family of THE RADIO DEALER.

Associated with Mr. Geesey is Mr. Herbert Krenz and he will assume direct charge of THE RADIO DEALER. Mr. Krenz has had a valuable experience in the advertising field and will be very pleased to give the best service possible to those interested in THE RADIO DEALER.

BALDWIN ORGANIZES

The Baldwin Radio Company of Salt Lake City, Utah, with a capital of \$1,000,000 has been organized and completely financed. The officers of same are David A. Smith, President; Lester D. Freed, Vice-President, and J. F. Nibley, Secretary and Treasurer.

This company has the license to manufacture the Nathaniel Baldwin Radio Telephone Headset and Loud Speaker and will market same in large productions.

The new daylight factory of the company, which has been specially built, will have a daily capacity of 2,000 complete head sets. Through improved methods of manufacture these telephones will be superior in sensitiveness and correct tone reproduction to the very excellent instruments which have heretofore been placed upon the market, which makes the Baldwin telephone the standard of the world.

Deliveries began the middle of July. The general office of the company will be 722 Kearns Building, Salt Lake City, Utah.

MANUFACTURERS — JOBBERS — DEALERS

PLACE YOUR FALL ORDERS FOR

EBY BINDING POSTS

NOW

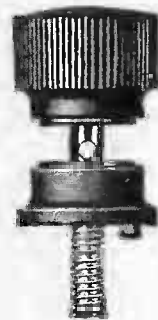

Commander "H" Ensign "H"

Sergeant "SS" Buddy

NOTE:—To satisfy the tremendous demands for Eby Posts we want responsible dealers everywhere to carry them. Jobbers! Write for Bulletin 10. Also latest discounts.

THE H. H. EBY MFG. CO., 605 Arch Street Philadelphia, Pa.

METROPOLITAN
243 Canal Street

Cable Address:
"METRADIO" N. Y.

M
E
T
R
A
D
I
O

RADIO CORPORATION
New York City

Phone:
Franklin 0939

WE ARE MANUFACTURERS

Of instruments and parts that are built right, to work right. All parts mechanically and electrically perfect.

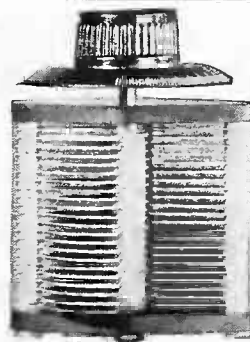

"METRADIO"

Variable Condenser

One of the best made condensers, rigid, accurately spaced plates.
43 plate, with knob and 3" dial complete \$4.75
23 plate, with knob and 3" dial complete

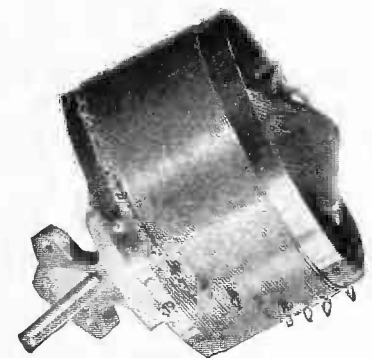

"METRADIO"

180° Vario-Coupler

Will hold range when once found. Easily installed, will operate perfectly, and give highest efficiency.
Price \$4.75

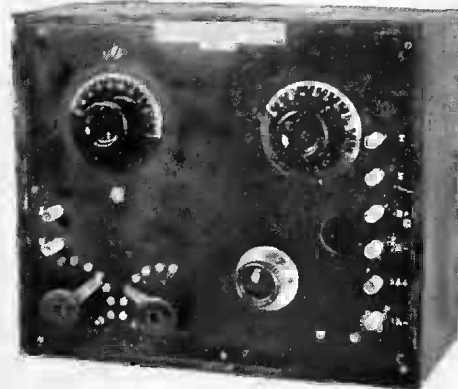

"METRADIO," One Tube Receiving Set

10" x 12" x 5 1/2"

Has tuning range 150 to 650 meters. Wonderful receiving power, clear tone and wide range. With this set you need not worry whether you will receive. All wiring is in the back of hard rubber panel enclosed in mahogany finished cabinet, thus giving it a very neat appearance.

Without tube or head phones . . \$37.50



"METRADIO"

Dial and knob complete,

3 inch . . 75 cents
2 inch . . 60 cents

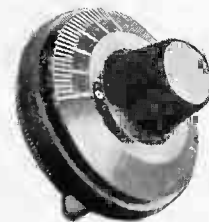

"METRADIO" Rheostats

One of the best rheostats on the market with 2" dial and knob.

Complete . . \$1.25

DISTRIBUTORS AND JOBBERS

Write for "METRADIO" complete tube machines and all parts. Territory open all over the country, apply at once. We make actual deliveries, not promises.

FRANKLIN VARIOMETER

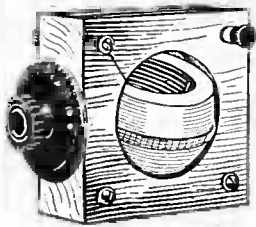

Made of selected hardwood. Permanent contacts assure smoothness of operation, unsurpassed by any other make.

Price \$4.50

Sample sent prepaid \$3.50

Dealers Write for Discounts

FRANKLIN RADIO MFG. CO.
711 Penn Ave. Wilkesburg, Pa.

ATTENTION MR. DEALER

Do you find any difficulties in obtaining your desired Radio supplies? If so, wire or write us your needs. We carry standard supplies that are sold with a guarantee.

A postcard will bring you our catalog.

Our Policy
Quality, Delivery, Guarantee

WHITE RADIO CO.

Distributors

141-3-5 West 33d Street
NEW YORK CITY

Jobbers and Dealers

Attention

STEEL—COPPER—BRASS
BRONZE—ALUMINUM
NICKEL SILVER
NICKEL—MONEL
DIAPHRAGM STEEL
MAGNETIC IRON
MAGNET STEEL

for

GUIDE RODS—SLIDES—TUBE
SOCKETS — CORES — METAL
PARTS — STAMPINGS, ETC.

used in the manufacture of
RADIO EQUIPMENT

"COPPERWELD"
ANTENNA WIRE

Immediate Shipment

Steel Sales Corporation

129 So. Jefferson St.
Chicago, Ill.

ENGLAND'S TROUBLES Broadcasting Slow Due to Lack of Plans

England's efforts to introduce wireless broadcasting on a large scale modeled after methods used in the United States has struck a decided snag because of the inability among the manufacturers to agree among themselves as to the best method for setting the scheme authorized by the government into operation. The Post-office Department, which controls wireless in England, some time ago approved the plan for the erection of eight stations, which were to be at widely separated points, and asked the manufacturers of wireless equipment to suggest a concrete and unanimous plan for their erection and operation. Although this request was made more than a month ago the government heard nothing more.

The main point of difference between the manufacturers, it is understood, is by whom the construction of these stations, each of which is to cost about \$100,000, shall be undertaken. At present there are two groups among the manufacturers, one wishing to construct all the stations and the other, comprising some smaller and less influential firms, being strongly opposed to such a proposal and characterizing it as a monopoly.

Another question disturbing the minds of the British wireless manufacturers is that of protection for British-made wireless sets. Thousands have already been sold on expectation of the amateurs that broadcasting would begin soon after the government authorization, but the manufacturers fear that after having paid the heavy costs of installing stations American manufacturers will flood the markets with receiving sets.

CORRECTION

In the July issue of THE RADIO DEALER it was stated in the advertisement of the "Duncan" aerial plug manufactured by the Super-Antenna Company of Quincy, Illinois, that the plug operated on current up to 120 volts. This should have read 150 volts, as the "Duncan" is considerably stronger in resistance than the advertisement indicated. THE RADIO DEALER takes this means of correcting the error, in justice to both the Super-Antenna Company and its product.

SOHM BANKRUPTCY

A voluntary petition in bankruptcy has been filed against the Sohm Electric Company of Chicago, with liabilities of \$22,109 and indicated assets of \$592,107.

The Sohm Co. manufactures electric time systems. Their business was established in 1915.

10,000

3 and 3 1/2 Inch
High Grade
Unbreakable

DIALS

At Maker's Cost

Address Box 104, Radio Dealer

For Finer Tuning use a

MORADIO

Every-Wire-Contact Coupler

LIST \$7.50

WRITE FOR PAMPHLET

Moreland Sales Corporation

30 Ogden St., Newark, N. J.

Ask Our Service Bureau

WHITEHOUSE GRID LEAK

an efficient, constant, interchangeable and compact "Grid Leak."

Not affected by Dampness,
or Temperature because of
the sealed GLASS TUBE

Splendid Proposition
to Dealers

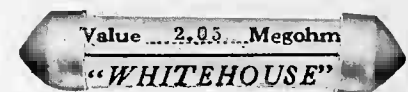

Designed to fit any standard base,
made in the following resistance
values: 0.5; 1.0; 1.5; 2.0; 2.5; 3.

Price - 70c Each

(Other values to order)

Every one tested and guaranteed.
If your dealer does not carry them,
send postal money order.

WHITEHOUSE RADIO & MFG. CO.

311 - 89th Street

Woodhaven, Long Island, N. Y.

Developing with Radio

(Continued from page 25)

the best interests of all concerned it was necessary for us to abandon our former practice of branding our products with the trade-marks of distributors, so-called, and to concentrate on the production of apparatus of the highest possible quality under our own well known and highly-respected trade-mark.

We then assured ourselves of ample production facilities with our skilled, competent workmen and trained, accurate female employes under the direction of careful, conscientious production men and checked back by laboratory methods.

Our completely equipped machine shop for the production of parts and dies, our own drop-hammer and punch press departments and steam power plant—the plating department, grinding and polishing rooms and assembling shops were all properly arranged and housed conveniently together in an airy, well lighted, three-story corner brick structure, personally owned by Mr. Max Klaas, of New York, the father of Mr. Robert Klaas, proprietor of the Radio Technical Laboratories and personally in charge of production.

We then began to advertise, and sought to establish connections in the various centres with well organized jobbers of financial responsibility having the required men, equipment and knowledge to enable them to market our products intelligently through their established dealers who were in the business to stay and were interested in building up a permanent goodwill.

In many cases we found it necessary to simply stay out of certain territories until the the legitimate jobbers decided to act, and although there is no question but that this policy lost us a vast amount of business at that time, since then it has meant that to date we have had but one cancellation, amounting to about one day's production, and we are busily engaged this summer filling bona-fide noncancellable orders from responsible people who appreciate honest merchandise and an honest merchandising policy and who realize that not as yet has even the surface been scratched of this wonderfully new field of recreation, instruction and enjoyment, and who know they can rely on us to keep our promises in the future as we have kept every promise made in the past and who look to us to keep them supplied with up-to-date radio apparatus as we develop it abreast of the times.

"East and West, the Globe is Best"



2200 Ohms
List Price
Only
\$9.00

GLOBE RADIO HEAD PHONES

Highly sensitive Matched receivers Natural in tone. Each receiver tested by radio. Light weight (11 oz.). Comfortable to wear. Specially designed adjustable headband. Will not distort signals when amplified. Articulation is perfect.

There are many types of head sets on the market but not too many good ones. The GLOBE RADIO HEAD SET incorporates a knowledge of acoustics not possessed by other companies. It embodies correct design with the best of materials.

THE GLOBE PHONES ARE FOR THOSE WHO DISCRIMINATE.
Ask about the Globe Antenna Attachment Plug for using electric light wire

GLOBE PHONE MFG. CO.
EARL C. HANSON, Technical Radio Expert
Reading, Mass., U. S. A.

"ASK OUR SERVICE BUREAU"

Dealers, Jobbers and Manufacturers who are not heeding this advice are missing a service that works with speed and efficiency, and in addition costs nothing.

If you want to buy anything in Radio

"Ask Our Service Bureau"

(Advertisement on Page EIGHT, this issue)

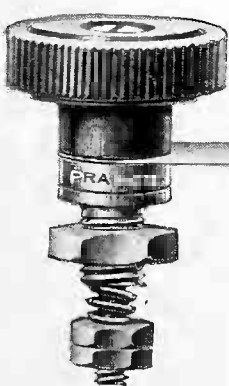

"PRAMCO"

TRADE MARK



Not merely a SWITCH POINT or BINDING POST, but the BEST. A superiority of workmanship and finish that eliminates all quality competition.

Assure your future business now. Articles with the name "PRAMCO" stamped on them need no apology.

PREMIER RADIO MFG. CO.

1900 No. 6th St. Philadelphia, Pa.

Switch Points, Binding Posts, Crystal Cups, Detector Posts,
Switch Levers, Etc.

Dealers and Jobbers get our quotations



U.S. RADIO CO.
OF PENNSYLVANIA INC.

\$100.00 will give you a complete stock of supplies to start a Radio department.

Write for full particulars.

When in the market for crystals, remember U. S. Eagle crystals are the best.

U. S. Radio Co. of Penna., Inc.
Manufacturer, Distributor and Importer
Corner Ferry and Diamond Sts.
Pittsburgh, Pa.

Ask Our Service Bureau

Detroit Electric Company
434 Shelby Street
Detroit, Mich.

Radio and Electrical Equipment

Established 1886

"COPPERWELD"
TRADE MARK REG. U. S. PAT. OFF.

ANTENNA WIRE

50% stronger than either solid or stranded copper

ELIMINATES SAGGING

Adopted by Largest Radio Corporations
100, 150, 200 ft. per Carton

LEAD-IN and GROUND WIRE

has the Underwriters' O. K. Rubber Insulated—Brown Braid
25, 50, 100 ft. per Carton

BUY IT IN CARTONS
with construction directions

COPPER CLAD STEEL COMPANY
New York Chicago
Braddock P. O., Rankin, Pa.

Have You Ideas?—

(Continued from page 23)

been granted on the same or similar invention, copies of the Letters Patent may be purchased for 10 cents from the United States Patent Office.

Radio inventors are encouraged in their highly valuable work by all business men. The fundamental idea of an invention is generally spontaneous, though it may take considerable time to work it out.

Any person, male or female, minor or adult, who develops something new and useful for the public benefit, is an inventor and is entitled to a patent protection in the United States. In such cases where the invention has been worked out by more than one person, a patent will be granted in the names of the individuals who have helped to develop the invention.

Voltaire said, "Ideas are like beards; men do not have them until they grow up." But when an age is in its infancy, like this age, the radio age, inexperienced amateurs often discover an idea of a practically simple device, system or appliance which may prove to have a useful and important function. In radio development, the field for new inventions is unlimited. The development of circuits, vacuum tubes, condensers, appliances, etc., are only in their experimental stage and may be revolutionized over night by a young unknown inventor.

The following axioms regarding inventions and patents proved to be useful to inventors and prospective inventors:

1. An invention belongs to anyone until patented.
2. Unpatented ideas are not profitable.
3. The simplest ideas have often resulted in the greatest good and most profit.
4. The fruit of one's mind shall be protected as well as his personal property.
5. A patent secured through reliable patent attorneys is a guarantee and protection against infringement.

If an inventor of a commercial article does not succeed in the radio field it is due to one of the following three reasons:

1. Failure to patent his invention.
2. Failure to receive adequate protection.
3. Failure to place his invention before the public.

Marconi said on June 20, 1922, when he received The Institute of Radio Engineers Medal of Honor, that "America leads in radio developments." America leads because Americans have inventive minds.

Boldo Radio Receiver



Is a high efficiency pocket wireless receiver, not a toy, but a practical Radio instrument. With ten hook-ups.

Dimensions: 3 3/4" x 3" x 1 1/4"

Weight: 6 oz. Retail price, \$15 without phones.

BOLDO RADIO & ELECTRIC CO.
30 North Fifth St., Philadelphia, Pa.
Dealers and Jobbers write for territory and discounts.

UNCONDITIONALLY Guaranteed for 1 Year

U. S. Storage Batteries

Supreme for Radio Telephone

A—Batteries

6 Volts 20 amp.	\$7.50
6 Volts 40 amp.	10.00
6 Volts 60 amp.	13.75
6 Volts 80 amp.	17.50
6 Volts 100 amp.	22.50

B—Batteries

9 Cell Voltage 22 1/2 V.	\$7.50
20 Cell Voltage 50 V.	13.75
40 Cell Voltage 100 V.	26.50

Liberal Discounts—Prompt Deliveries

U. S. STORAGE BATTERY CO.
P. O. Box 523, FAR ROCKAWAY, N. Y.

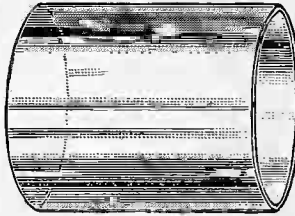

Glass Tubes for Crystal Detector Sets

Special Prices in Quantity

Vineland Scientific Glass Co.
New York Office 1133 Broadway
Factory Vineland, N. J.

The Comet Battery Co.

Manufacturers

Radio "B" Batteries

Cleveland, Ohio

ATTENTION!

Manufacturers of high class guaranteed Radio Sets and equipment. An efficient selling organization is open for connections as Factory Representatives.

Radio Sets must be high class, yet moderately priced, and able to receive concerts and other news a distance of at least one hundred and seventy-five miles.

James R. Sheedy
Executive Office
Press Bldg., Binghamton, N. Y.

Make Radio Parts

Wilcox Laboratories Feature Concert Set

A complete line of radio parts is made by the Wilcox Laboratories of Lansing, Michigan, who have been in the business since 1912.

The laboratories are featuring at present the Wilcox Radio Concert Receiver, whose special qualities are that it will faithfully reproduce music and speech without distortion, according to the makers.

This result is achieved by a new circuit and a new combination of instruments which has reduced the number of variable controls to two. The manufacturers of this set claim to have thus placed in the hands of the man or woman without previous knowledge of radio a set that may easily be installed and operated without the slightest difficulty.

The price of the Wilcox Radio Concert Receiver is \$20.00. The Wilcox Laboratories also produce switches, dials, dial pointers, plugs, rheostats, knobs, binding posts, variometers and parts, varicouplers and parts, sockets, etc., and are wholesale distributors of nationally known batteries, headphones and lightning arresters. Their address is 2208 E. Michigan avenue, Lansing, Michigan.

SOLVES WIRING SNAG

Wiring Variometers and Couplers have been one of the great problems which manufacturers have had to contend with. Now there is on the market an electric motor, 1/12 horsepower, which operates on either A. C. or D. C., and which can be run from a very slow movement to a high speed. The speed is controlled by a foot rheostat, and the variations are unlimited between the minimum and the maximum, and every slight pressure will change the speed.

These motors are made with aluminum casings and are fully guaranteed. They are equipped with a pulley and an extended shaft, and are entirely satisfactory for wiring of variometers, etc.

These motors can be had from Henry Paulson & Co., 37 South Wabash Avenue, Chicago, Illinois, who are jobbers in radio apparatus.

PEER LEAVES SUPERIOR

R. H. Peer wishes to notify the trade that he has severed his connections as Secretary and Manager of the Superior Radio Equipment Co., Inc., of New York, and is now connected with a well known manufacturer.

KEYSTONE

FILAMENT RHEOSTAT

V. T. SOCKET

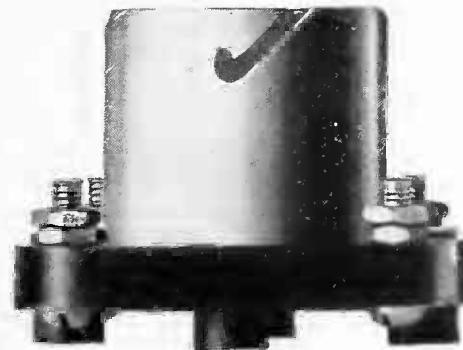

Resistance, 6 Ohms.
Carrying Capacity, 1 1/2 Amps.
Base, made of black moulded Bakelite.
All parts made of brass and nickel plated.
Large Knob, and polished pointer.
List Price, \$1.00

BASE and feet of moulded natural color Bakelite.
Contact Springs, Heavy Phosphor Bronze.
Heavy binding post.
Tube of heavy, polished Aluminum.
All brass parts nickel plated.
List Price, 90 Cents

Dealers and Jobbers, wire or write for discounts—Immediate Delivery

MANUFACTURED BY
KEYSTONE RADIO COMPANY

Dept. D.

GREENVILLE, PENN.

Take advantage of this offer and don't
be caught with empty shelves
September 1st.

10 1/4 lb. spools	10 1/2 lb. spools	No. 20 Sin. Cot. Magnet Wire.
10 1/4 lb. "	10 1/2 lb. "	No. 22 " " " "
10 1/4 lb. "	10 1/2 lb. "	No. 24 " " " "
10 1/4 lb. "	10 1/2 lb. "	No. 20 Dble. Cot. Cov. Magnet Wire.
10 1/4 lb. "	10 1/2 lb. "	No. 22 " " " "
10 1/4 lb. "	10 1/2 lb. "	No. 24 " " " "
10 1/4 lb. "	10 1/2 lb. "	No. 20 Enameled Magnet Wire.
10 1/4 lb. "	10 1/2 lb. "	No. 22 " " " "
10 1/4 lb. "	10 1/2 lb. "	No. 24 " " " "
10 100 ft. coils	No. 14 Stranded Copper Antenna Wire.	

As above for immediate shipment, check with order \$47.00

1/2 of above 5 items each size \$25.00

Let us quote you on your wire requirements

RICHMOND ELECTRIC COMPANY

AUTO, ELECTRIC AND MAGNET WIRES

Wholesale Only

181 McDOUGAL STREET

BROOKLYN, N. Y.

We Specialize in

Brass Rod and Tubing
Sheet Copper, Aerial Wire
and Binding Posts

McKenna Brass and Mfg. Co.

First Ave. and Ross St., Pittsburgh, Pa.

Phone, Court 637

**SPAGHETTI FOR
IMMEDIATE DELIVERY**

Smooth, Heavily Coated, Flexible,
Woven Tubing of Great Dielectric
Strength and is Without an Equal
as an Insulator. Black or Yellow in

10,000 ft. lots.....	.03
5,000 " ".....	.0325
1,000 " ".....	.0350
500 " ".....	.0375
Less than 500.....	.0425

SAMPLES UPON REQUEST

JEWEL RADIO CO.

1114 S. Michigan Ave. Chicago, Ill.

Immediate Shipment

on

IRVINGTON

Flexible Varnished Tubing
"Spaghetti"

5000 Volts—Puncture Test

also on

**AERWIN
PRODUCTS**

Variocouplers
Variometers
Special Detector Crystal
Model A Receiving Unit
Collapsible Loop Antenna

"Kentone" Radio Amplifying Horn

WRITE

The Mills Radio & Electric Co.
Incorporated

1010 Springfield Avenue
Irvington, N. J.

Money in Radio

(Continued from page 28)

sarily, and in fact seldom is, a one-sale proposition.

The radio user often decides to add to his set, but he goes to the dealer who can "deliver the goods." This last phrase has another highly important signification, and brings up a point that no radio dealer can afford to overlook. Heavy demand for radio apparatus often creates a great scarcity of radio parts. Thus vacuum tubes have been extremely difficult to get in the past, telephone head sets have been scarce at times, etc. The dealer should be very cautious about taking orders which he cannot possibly fill for eight or nine months. Paper profits usually mean actual loss. Although at the present time manufacturers have apparently caught up with the demand, it is very likely that there will be a shortage of radio material again in the fall and dealers should be far sighted enough to stock up sufficiently to take care of the demand.

The radio dealer should take advantage of free newspaper publicity. He should also advertise but should be careful to pick the best advertising mediums. Local newspapers which carry a radio page are first-rate advertising mediums, also popular radio magazines, etc. The advertiser must be able to differentiate his particular offering from that of his competitor. Since the price of the sets are fairly well standardized, the dealer must offer other reasons for the prospective radio buyer to visit him. The dealer may advertise free radio advice or consultation in connection with the sets which he handles, or he may couple up his sales work with an efficient antenna installation department. By charging a nominal sum for erecting the aerial he can cover his costs as far as this is concerned and at the same time he is sure that the radio sets are installed to the best advantage. As a result his sales will be bound to increase. Another plan which the dealer may adopt, is to construct a strong electromagnet and use this to remagnetize, without charge, all telephone receivers purchased from him with radiophone sets. By charging for remagnetizing phones purchased elsewhere, an additional source of revenue is obtained, as well as a means of attracting new customers.

The dealer can do a great deal of propaganda work which will eventually become a source of profit. He should foster and help organize radio clubs and see to it that his store becomes the general headquarters for

T-B-H Head Sets

List \$8.00

Sold on a Money Back Guarantee
8000 TURNS PER RECEIVER

(2000 Ohms Resistance)

Aluminum Backs

6 Ft. Moisture Proof Cord

Jobbers—Dealers

Write for Discounts

Telephone Book Holder Corp.

Dansville, New York

ELCO RADIO SUPPLY CO.

Manufacturers'
Distributors

2728 Broadway, New York City

Moss Radio Company

Jobbers in

Radio Sets and Equipments

202 West 23rd Street

New York City

Phone Watkins 5078

Manufacturers of

GRID CONDENSERS

VARIABLE GRID LEAKS

**VERNIER-VARIABLE CON-
DENSERS**

PHONE CONDENSERS

FIXED PHONE CONDENSERS

BAKELITE DIALS

BUNTING STAMP CO.

713 Liberty Ave.

Pittsburgh, Pa.

Free Will help **YOU** increase sales

This catalog will show you how to secure the names of your best prospective customers, those you want to reach most. Counts and prices are given on thousands of different lists, covering business concerns, professions and individuals, such as Noodle Manufacturers, Druggists, Coal Mines, Farmers, etc. Personalized sales letters and descriptive literature mailed to live prospects will increase your sales by creating direct orders or inquiries.

99% Guaranteed Mailing Lists backed by our 5¢ refund

Insure your getting up-to-date information, for our lists must be compiled from latest sources to avoid heavy losses through the guarantee.

Send for FREE Reference Book today
A postcard will bring this valuable sales help.
ROSS-GOULD CO., N.10th, St. Louis.

Ross-Gould
Mailing
Lists St. Louis

1/8 Automatic Screw Machine Products **2**

MERIT MACHINE MFG. CORP.
465 Greenwich Street
New York, N. Y.
Phone CANal 9128
9th Ave. L. Desbrosses St. Station

necessary supplies. New members will then mean new business.

In the smaller towns the dealer will have splendid opportunities to increase his sales. He should rig up a portable demonstration set and give everyone for miles around an opportunity to listen in on the broadcasting. The radio man can carry with him a powerful argument for "keeping them down on the farm," and he should see to it that every farmer within receiving range of the broadcasting stations buys a receiving set. The demonstration outfit can be shown before social clubs, fraternal orders, women's clubs, boys' clubs and arrangements should also be made to demonstrate the outfit before church organizations and in schools. It would even be feasible to give a free demonstration at the local movie theatre. Such a stunt undoubtedly could be carried through to the mutual advantage of the theatre owner and the radio dealer.

Radio telephone sets, in addition to being marketed by men specializing in this field, are being sold in the most unexpected places. Of course it is a very natural thing to find the electrical dealers and the electrical contractors turning to this new and profitable electrical field. The electrical men have a slight but not overwhelming advantage because of their familiarity with things electrical.

However, radio sets have been and are being sold extensively by department stores, sporting goods, phonograph, optical and hardware stores. This list is continually growing until it seems as if radiophones would soon be available at every corner store. However, it behooves the man who contemplates entering or who has already entered this field to "know" the game at least to the extent indicated above in order to make himself fit to survive.

(Copyright 1922, by H. C. Cisin)

WELL DESIGNED UNITS

Transmitting, receiving and amplifying units designed especially for voice receiving are produced in the factory of the Wireless Phone Corporation, 193 Ellison Street, Paterson, N. J. They solicit inquiries from jobbers and retailers.

STEINMETZ TO RUN

Dr. Charles P. Steinmetz, the General Electric Company expert, the recent producer of an artificial thunderbolt, will have a place on the Socialist ticket, for New York State, this Fall. Dr. Steinmetz, who is an old member of the party, will be offered to the public as a candidate for State Engineer.

THE PARAGON

Audio-Frequency Amplifier TRANSFORMER

has been produced as a radio telephone amplifier transformer which reduces tone distortion and eliminates scratching, hissing or shallow tones.

This is accomplished by the free use of high grade silicon steel in the laminated core, the provision of a magnetic field which is practically perfect and the careful proportioning of the windings.

May be mounted on either panel or base. Occupies a minimum space and is readily accessible.

List Price \$5.00

LIBERAL DISCOUNTS TO DEALERS

E. M. WILSON & SON

11 Lafayette Street, at Broad, Newark, N. J.
Phone: Market 0714

SEABOARD

PRODUCTS

QUALITY

ECONOMY

STURDY
CONSTRUCTION
PERFECT
INSULATION
SPECIAL SHAFT-
CONTACT BEARING
ADJUSTED, TESTED
AND INSPECTED
BEFORE SHIPMENT

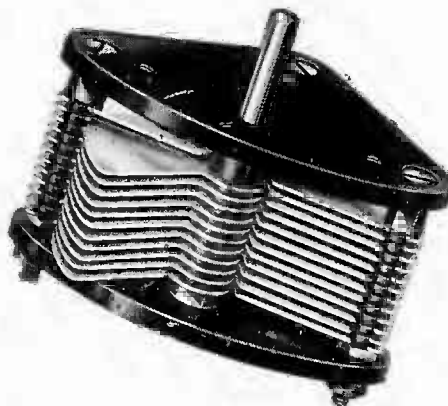

23 PLATES
CAPACITY .0005 MFD.
DEPENDABLE
EFFICIENT
GUARANTEED
LOW PRICE

PRICE \$3.00

No 1 Variable Condenser for Panel Mounting

IMMEDIATE DELIVERY

JOBBERS AND DEALERS—WRITE FOR DISCOUNTS

SEABOARD RADIO CORPORATION

266 GRAND STREET
NEW YORK CITY

RADIO PANELS

And other insulation for Wireless Work

BAKELITE-DILECTO

Grade XX Black was used by the Government during the war for this purpose. It is the

Standard of the World

THE CONTINENTAL FIBRE COMPANY

NEWARK, DEL.

New York, 233 Broadway
Pittsburgh, 301 Fifth Ave.
Los Angeles, 411 S. Main St.
Seattle, Wash., 1927 First Ave., South

Chicago, 332 S. Michigan Ave.
San Francisco, 75 Fremont St.
Rochester, N. Y., 85 Plymouth Ave.,
South



JENKINS VERNIER RHEOSTAT
Indispensable for adjustment on Radio Frequency and Detector Tubes. Patent instant cut-off switch. Write for folder. Liberal discounts to dealers and jobbers.

J.E. Jenkins Not Inc.
59 E. Van Buren St. CHICAGO

\$1.75

PATENTS
on radio inventions apply to
OTTO K. ZWINGENBERGER
38 Park Row, New York
Cortlandt 3207

M-R FLEXIBLE VARNISHED TUBING
THE GENUINE
"SPAGHETTI"
TWO STYLES—BEST GRADES MADE—ALL SIZES—ALL COLORS
Varnishes, Waxes, Compounds, Papers, etc.
MITCHELL-RAND MFG. CO.
14 VESEY STREET NEW YORK, N. Y.

PAPER TUBES FOR WIRELESS
ALL SIZES ON HAND
FOR IMMEDIATE DELIVERY
WHOLESALE AND RETAIL
BAEHM PAPER CO., Inc.
219 Fulton Street New York
Bet. Church and Greenwich Sts.

NOTE TO THE TRADE:
Quote us prices, terms, discounts and deliveries
WE ARE DISTRIBUTORS exclusively via mail order
Complete sets
Radio Equipment
SPECIALTIES
Manufacturers
Desirous of New York Representation communicate at once
RADIO EQUIPMENT SERVICE
500 FIFTH AVENUE
NEW YORK CITY

Urge Free Duty

Fans Want Duty Free Vacuum Tubes

Radio vacuum tubes were asked placed on the free list in the pending tariff bill in a letter and petition presented to the Senate by Senator Edge of New Jersey, which request was referred to the finance committee.

The request was made to the Senator by Nelson Dunham of New Brunswick, known all over the state for his leadership of amateur radio enthusiasts. The petition accompanying the letter was signed by J. H. W. Taylor, as president of the Plainfield Radio Association, in behalf of other New Jersey radio clubs and associations. The basis of the request for the placing of the tubes on the free list was the assertion that there exists a monopoly in the manufacture, sale, use and importation of radio apparatus which should not, in the opinion of the petitioners, be encouraged by tariff protection.

Mr. Dunham in his letter to Senator Edge declared that radio amateurs everywhere are deeply interested and feel that certain corporations are "seeking a strangle hold which affects that which is fast becoming a public utility service."

In its petition to the Senate the Radio Association calls attention to the testimony before the radio conference committee, appointed early this year by Secretary of Commerce Hoover, to one of that committee's basic recommendations that radio apparatus should be freed of existing restrictions and to the alleged fact that the importation of radio vacuum tubes, even for government purposes, "is virtually prohibited by the combine or its affiliated interests." Thus, it is pointed out, this country is restricted to tubes of comparatively inferior quality and to a limited selection as to power and type. To indicate this restriction, it is stated in the petition that four-element tubes are not obtainable in this country, although freely made and used abroad.

"We do not presume to express an opinion," the petition continues, "as to whether a patent monopoly can legitimately be combined with all other patents and patent rights of like nature. It is manifest, however, that such combinations can be used to defeat the anti-trust laws, are contrary to public policy, and should not be fostered by tariff protection.

"We believe that the Army and Navy departments have a large surplus quantity of radio vacuum tubes, the disposal of which has been tied up

P. D. JACKSON

Direct Factory Representative
Radio Equipment Manufacturers
OFFICE AND WAREHOUSE
1441 South State Street, Chicago, Ill.

NOTICE! WE WANT LIVE, RESPONSIBLE DEALERS
in every city in the United States to sell our Super-efficient Broadcast Receiver. We can offer you very attractive discounts and immediate shipment. Write or wire immediately.
W. R. CRAMER CO., OMAHA, NEB.
PIONEER RADIO MANUFACTURERS

ELECTRICAL TESTING
of all material entering into Radio Construction. Also Chemical Analyses and Strength Tests.
Bowling Green 7016
New York Testing Laboratories
80 Washington St. New York City

PATENT
your ideas. Protect your rights by U. S. and Foreign Patents and Trade-Marks. Moderate rates. CALL, WRITE or send us your invention.
May one of our representatives call on you?
FREE CONSULTATION
Phone: Vanderbilt 7212.
ASK MANUFACTURERS PATENT CO.
FOR 520 FIFTH AVE NEW YORK

SCREW MACHINES IDLE
Battery of Seven Automatic Screw Machines for Making Parts for Radio Equipment.
SEND BLUE PRINTS AND SPECIFY QUANTITY
The Carlyle Johnson Machine Co.
MANCHESTER, CONN.

IMMEDIATE DELIVERY ALUMINUM
SUITABLE FOR RADIO PARTS
Moulding, Bar, Rivets, Tubing, Ingot
STRAHS ALUMINUM CO.
53 Grand Street, N. Y.

RADIO BOXES AND CABINETS

Send us your specification and let us figure on your requirements.
PROMPT DELIVERIES.

THE WEIS MFG. CO.
Monroe, Mich.

by those interested in the monopoly. Inquiries made abroad meet with replies to the effect that importation of such tubes into this country is prohibited, not by reason of the tariff, but by the control here of foreign patents and patent rights.

"Your petitioners pray that radio vacuum tubes be placed on the free list, at least for research and amateur experimental purposes."

UNITS EDUCATIVE FACTOR

Electrical manufacturers for twelve years, the Chelton Electric Co. of Philadelphia were not taken aback when the phenomenal rise of the Radio made its enormous demands upon qualitative and quantitative production of precision instruments.

The Chelton line of Radio apparatus includes rheostats, dials, condensers, grid leaks and caps, tube sockets, lightning arresters, switches, and receiving sets both in units and assembled outfits.

Four units comprise the Chelton "Educator," designed to suit the needs of the radio enthusiasts as well as being an educative factor by permitting of expansion in accordance with the radio knowledge of the "fan." The Chelton company claims that the four units, the tickler coil cabinet, the condenser cabinet, the detector cabinet and the two-stage amplifier cabinet, make the most flexible receiving set on the market. Any new developments, they say, can easily be inserted between the cabinets without making any portion of the set obsolete.

DISTRIBUTORS FOR FRANCO

Long established as distributors of electrical supplies, the Garfield Electrical Supply Co., Inc., of New York, are now distributors of nationally-known Radio products including Franco Radio "B" batteries.

They are also the makers and distributors of the Garfield dial, which is said to be unbreakable.

Radio has grown so rapidly during the past year that it is impossible to determine the exact number of apartments in New York City equipped with radio receiving sets; however, a fair estimate for the present day would be 75,000 to 100,000.—*New York Times*.

MAKING RADIO HEAD SETS

The Triangle Phono Parts Co., 722 Atlantic avenue, Brooklyn, N. Y., well-known manufacturer of motors and tone arms, recently entered the radio field as the manufacturer of head sets for radio receiving apparatus.

DEALERS and JOBBERS

The best radio proposition in the field

Every radio set sold—every new radio fan—every old radio fan—represents a possible sale of THE RADIO READING COURSE for the live dealers and jobbers handling the Course. This is just the kind of instruction that the public wants. In five handsome Lecture Books that eliminate long, tedious study. Absolutely authoritative and up-to-date. The biggest selling set of radio books in the English language.

WRITE FOR SPECIAL PROPOSITION

Sales are easy and profitable—more profitable than most apparatus. If you want to cash in on the special proposition now being made write at once for details and a copy of the Course. But act at once to be the first in your territory.

Also ask for our prices and discounts on higher grade apparatus.

Address RADIO COURSES, Inc., Wholesale Dept., 552 Seventh Ave., New York

RADIO DEALERS

We are Jobbers for many manufacturers of high class Radio Apparatus and Supplies

CITY SUPPLY CO.

56 Warren St.

New York City

Tel. Barclay 6613

TRU-TONE PRODUCTS

A Real Spark in Radio

IS YOUR GUARANTEE

for

HEAD SETS—3000 AND 4000 OHMS
CRYSTAL SETS WITH PHONES—PROTECTOR, ETC.
NON-REGENERATIVE TUNERS AND DETECTOR.
RADIO AND AUDIO FREQUENCY
ONE—TWO—THREE STEP AMPLIFIERS

Catalogues to

JOBBERS—DEALERS—DIRECT

Manufactured by

INTERSTATE RADIO CORP.

16-18 West 22nd St.

New York, N. Y.



Real Apparatus
Popular Prices
Good Discounts
Prompt Deliveries
Package Packed
P. E. Edelman, E.E.
Mfr.
9 Church Street
New York, N. Y.

THREE STYLES OF BATTERIES

To meet the growing demand for a really reliable storage battery for radio work the Gardner Storage Battery Company announces the advent of the Gardner Radio "A" Battery, which is now being put on the market in commercial quantities after having been thoroughly tried out and tested for this branch of storage work.

This battery is a six volt instrument and is made in three sizes, 40 amperes, 60 amperes and 80 amperes. Either of the three sizes may be used interchangeably on the same set, the only difference being that the smaller size will need recharging oftener than the larger size with the same amount of use.

Two styles of battery coverings are used in the Gardner line. One is the ordinary plain battery covering with handles with which the battery may be lifted. The second style is inclosed in a mahogany finished case, as ornamental as the modern high class victrola, thus making the whole radio set more and more accessible for parlor use.

MAIN UNIT SETS

The Main Radiophone Receiving set, made by the Main Radio Company, is built up in convenient form, that of unit style cabinets, so a customer can start with a tuner unit and detector unit, and have a range up to three hundred miles under favorable conditions with a head phone.

This set uses the famous regenerative circuit which makes for efficiency. The natural color genuine mahogany cabinets, with black polished formica panels, attractive dials, (gradations in white), nicked nuts and screws, jacks, etc., presents a very pleasing appearance.

DESIGNED FOR AMATEUR

The Acme phone, made by the Acme Apparatus Company, has been developed for the use of those having no knowledge of radio practice. It is a complete receiving set to operate which no more skill is required than there is in running a phonograph or a player piano.

The company has also recently added to its line some transmitting apparatus, which include spark transformers, C. W. transformers, filament heating transformers, modulation transformers, choke coils and inductances.

Ask Our Service Bureau

ROCKY MOUNTAIN CRYSTALS

Better Than Galena

The most sensitive mineral rectifier known. Can also be used with one or more stages of amplification.

Mounted 35c. Unmounted 20c. Postpaid

Manufacturers, Jobbers, Dealers, Clubs.

Apply for Special Prices.

Rocky Mountain Radio Products, Inc.
9 Church Street, New York, N. Y.

DEALERS

Here's a big money-maker for you



Binding Post

Hard Rubber Top,
Standard size
Nickel bases
with brass screw
and washers, assembled complete.

Natural size

\$5.00 Per
List 100

Write for discounts and samples

Royal Eastern Electrical Supply Co.
116 West 27th St. New York

It pays to advertise—ask our advertisers.

If you have something to sell the Radio Trade, fill in the blank below—an ad this size would only cost \$18.60 per issue on contract

ADVERTISING ORDER

HARRY M. KONWISER, Publisher,
THE RADIO DEALER,
1133 Broadway, New York City.

You may insert our advertisement, copy attached, in the next 12 issues of the RADIO DEALER, to occupy space of six inches, for which we agree to pay you at the rate of \$18.60 per issue.

(Signed)

(Address)

(City and State)

Minimum order, four inches

Stanton's WIRELESS Bulletin



The Authority on Wireless Stocks

Reynolds Spring Co.

Radio Corp. of America Spanish Marconi
American Marconi Canadian Marconi
English Marconi Federal Tel. & Tel.
De Forest Radio Tel. & Tel.

FRANK T. STANTON & CO.
Broad 5819 35 Broad St., N. Y. C.

THORNTON

AUDIO FREQUENCY
AMPLIFYING TRANSFORMERS

Supreme Test Transformer

These transformers are supplied in either mounted or unmounted types. Special attention paid to the manufacturer of receiving sets.

THORNTON
TRANSFORMER CO., Inc.
30 Church Street, New York City

Noisy "B" Batteries

(Continued from page 24)

In selling "B" Batteries the radio dealer should point out to the customer that in certain hook-ups where the same group of batteries is used for the detector and high voltage amplifier that those batteries or that section of a battery which is used on the detector and amplifying circuit will be discharged sooner than will the rest of the battery. The customer should be advised to change his batteries from time to time, so that the unequal drain between the detector and amplifier tubes can be distributed between them.

With reference to high voltage batteries for loud speakers it is recommended that individual "B" Battery units of 22.5 volts be connected together in series and placed in a convenient box rather than for the customer to purchase a large unit already sealed and assembled. By having a number of batteries the customer can test them individually and watch their operation. In a single sealed-in unit this is impossible as the manufacturers seal the battery to prevent tampering with its cell connections.

POSTAL RADIO WILL INCLUDE TELEPHONE

The fifteen radio stations maintained by the postoffice department in connection with the operation of the air mail service will probably be changed gradually to provide both radio telegraph and radio telephone service, according to Postmaster General Work. The Washington station has had both radio telegraph and radio telephone service for nine months.

In addition to maintaining an hour to hour record of the progress of the airplanes carrying mail, the postoffice department stations now send out complete weather reports, data concerning grain, dairy and livestock.

CONGRESS LIBRARY'S NEEDS

In the hope that some owner of the first two issues of THE RADIO DEALER is willing to have them deposited in the National Library, the Library of Congress, Periodical Division, has asked THE RADIO DEALER to issue this call for April and May back numbers of the "national journal of the radio industry," so that the file may be complete.

THE RADIO DEALER is itself unable to furnish the two issues to complete the file of the publication in the Library of Congress, but is only too pleased to broadcast this call for back numbers.



\$3.75

MADE IN NEWARK N.J. PAT. PENDG.

Rad'O Crystal Attachment

For Your Crystal Set Use One Ear Phone, a RAD'O and the Whole Family Can Listen In

Made of Aluminum—and designed according to the laws of acoustics, and guaranteed to give satisfaction. Tubes of best quality rubber, with heavy walls; the ear tubes made of hard rubber and easily kept in sanitary condition. By the use of the Rad'O all distortion is eliminated.

Jobbers Communicate **RAD'O, P. O. BOX 418, NEWARK, N. J.** Dealers Ask Your Jobber

MR. RADIO RETAILER!

You NEED This Paper. Do you think it will be worth a dollar to get THE RADIO DEALER every month for the next year? Use the blank below, rubber stamp or print your name and address, then mail to us. Do it today.

HARRY M. KONWISER, *Publisher,*
The Radio Dealer,
1133 Broadway,
New York City.

Please send **THE RADIO DEALER** to the following address for one year

for which { we enclose one dollar
 { we will send one dollar on receipt of bill.

(Name)

(Address)

(City and State)

Make remittance by check, money order or registered mail

What the Manufacturers Are Doing

Chelsea Variable Grid Leak Patented

The Chelsea Radio Company, Chelsea, Mass., has just been granted a patent on their variable grid leak, under the date of June 20, 1922, No.



1,420,189. The great value of this device can only be realized by actual trial, or by an understanding of the operation of the vacuum tube.

When the filament of the vacuum tube is lighted negative electrons are thrown off in all directions, but as the plate element is made positive by connection to the "B" battery, the negative electrons are drawn in a stream to the plate. The grid which is the con-

trolling member is placed in the stream midway between the filament and the plate.

If the grid is positively electrified, it increases the electron stream, and if negatively electrified it reduces the flow of current; and if the grid becomes sufficiently charged negatively, it may stop the flow of current altogether.

In practise the antenna or its equivalent is connected to the grid of the tube which alternately becomes positively and negatively charged. During the positive cycle all the negative electrons are not removed from the grid and during the many succeeding oscillations the charge builds up and materially stops the flow of current.

The amount of this negative accumulation varies with the incandescence of the filament, the positive potential on the plate, the degree of evacuation of the tube, and the gas content of the tube.

To meet these varying conditions a fixed value of grid leak is insufficient

and cannot maintain the tube at its proper operating condition.

The Chelsea variable grid leak consists of ten carefully calibrated values of grid resistance ranging from one quarter megohm to five megohms.

By proper adjustment of the grid leak resistance the potential of the grid is changed at will and hence the value of the electron stream and signal intensity. This means that the vacuum tube may always be in the most sensitive condition and free from all disturbing noises.

The variable grid leak may be connected in shunt with the grid condenser or from grid to filament with equally good results.

CLEAR SOUND HEAD SETS

The Dictograph Products Corporation, specialists in super-sensitive sound-reproducing apparatus, have entered the radio field with a head set and loud speaker which are being distributed to the trade through the regular jobber-to-dealer channels.

It is said that a new principle has been used to produce apparatus that will respond even to the faintest and most delicate sound impulses, and to give clean and distant tones.

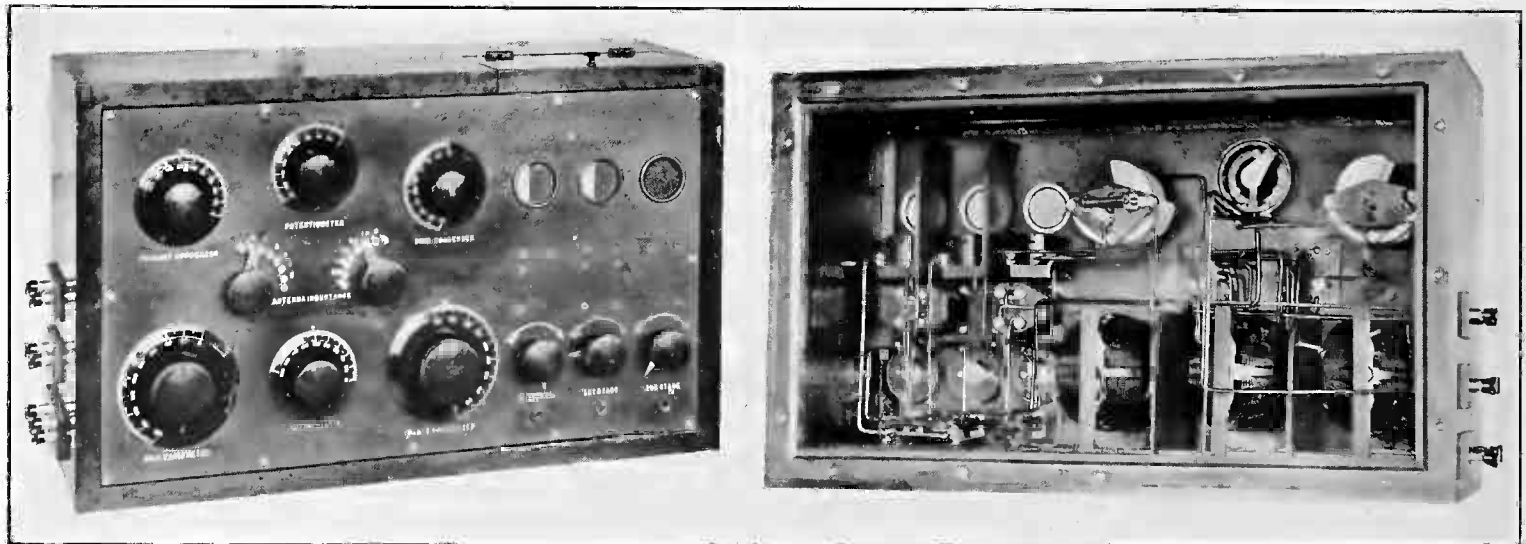

KNOCK-DOWN SET

One of the centers of attraction at the show which just closed in Chicago, was a knock-down set exhibited by the Nash-Odell Co., 172 N. Franklin St., Chicago, Ill., designed to supply the demand created by the man who desires to assemble his own equipment without need of shopping

around for parts and experiencing the grief of panel drilling, etc.

This apparatus includes standard tested parts, a 3/4" solid hand finished cabinet, a panel 12" x 21", shielded, drilled and engraved, wire, spaghetti, solder, screws, nuts, etc., making an equipment comparable to apparatus selling for from \$300 to \$350 and at less than one-half of these figures.

A large distribution is assured as indicated by the pending appointment of jobbers and distributors for the various geographical sections of the country, at discounts which are quite favorable. The photograph shown herewith indicates only to a small degree the high caliber and make-up of this set, it having been very favorably commented upon at the show.

Trade - Mark Department

Conducted by Chauncey P. Carter,
Trade-mark Specialist
of Washington, D. C.

NEW RADIO TRADE MARKS

Part I—Accepted for registration in
the Patent Office

June 27

Aero Fone—Wireless telephone receiving sets—Prometheus Electric Co., New York, N. Y. Use since January 28, 1921, claimed.

Merco—Overload relays, Brown and Pengilly, Los Angeles, Cal. Use since March 1, 1919, claimed.

July 4

Western Electric—Various radio apparatus, Western Electric Co., New York, N. Y. Use since January, 1910, claimed.

Part II—Registered in the Radio Dealer Trade-mark Bureau

Etherola—Aerial equalizer tubes, ground separator tubes, cabinet receiver and other radio equipment and supplies. Ralph A. McKinney, 489 Union Arcade Building, Pittsburgh, Pa. Adopted February 13, 1922.

COAST DISTRIBUTOR ALERT

Paul F. Johnson, the wide-awake Pasadena Radio Distributor, who prides himself on being "one-hundred per cent radio" is handling the Burgess "B" Batteries. They represent the result of years of experience in dry battery manufacture combined with the most careful scientific study of the particular and peculiar requirements to be met in a successful "B" battery.

The makers claim for them the qualities of noiselessness, long shelf life, high capacity and moderate price, making them the most satisfactory source of plate voltage. With seamless drawn zinc cans, individual cell insulation, moisture-proof containers, and special mix, howling is eliminated, the makers say, and expense reduced, for the Burgess batteries can be used to the last milliamperere, at a low cost per hour.

Batteries are of standard size and will fit interchangeably. They are made in four sizes for radio equipment with prices ranging from \$3.00 to 40 cents. Mr. Johnson is proud of this line, and it is one of the keystones of his business at 90 North Los Robles Avenue, Pasadena.

WHY EXPERIMENT—MR. MANUFACTURER?

For years we have been cutting, drilling, machining, grain-ing and polishing Bakelite Dilecto.

Put this experience to work on your panels. Write us for proposition and sample.

STANDARD WIRELESS PANEL COMPANY

49 MECHANIC STREET

NEWARK, N. J.

"EURACO" MICA GRID CONDENSERS AND LEAKS

Price 60 cents
(Designed to fit Standard Grid Leak Base)

GRID LEAK VALUES:

.5—1.0—1.5
2.0—2.5—3.0
Megohms

Price, 60 Cents



COMPACT,
INTER-
CHANGEABLE,
HANDY,
MOST
EFFICIENT

"Euraco" Condensers are composed of Copper Sheet and Best Grade India Ruby Mica, and are entirely Hand Made.

Manufactured in following capacities:

.00025 Mfd—Correct for Myers Radio-Audion RAC-3
.0001 " —For Special or Experimental Circuits
.00025 " —Correct for Super-Hetrodyne & UV 201
.0005 " —Correct for Radiotron UV 200

Condenser—Leak Mountings

Bakelite Base with Single Mounting\$.40
Bakelite Base with Double Mounting60
Bakelite Base with Triple Mounting80

SHIP OWNERS RADIO SERVICE CO., DISTRIBUTORS

EUROPEAN RADIO COMPANY

1342 East 22nd Street,

Manufacturers

BROOKLYN, N. Y.

Interesting Proposition to Dealers

Trade-Marks Secure Trade Registrations Secure Trade-Marks

I Secure Registrations

CHAUNCEY P. CARTER

Radio Trade-Mark Specialist

4907 Potomac Avenue, N. W. Washington, D. C.

Correspondents in all countries

Fine Cuts for Illustrating
**CENTRAL ELECTROTYPE
FOUNDRY COMPANY**

Electrotyping and Engravings
9 Campbell Street Newark, N. J.
Telephone: Mulberry 1698

BEACON Radio & Electric Co.
NATIONAL DISTRIBUTORS

What do you want?
WE HAVE IT
Watch for Next Month's Advertisement
246-248 Greenwich Ave., New York City

EVEREADY

RADIO "A" BATTERY

Immediate Delivery from Stock
Manhattan
Storage Battery Co., Inc.
204 West 76th Street
New York City

DEALERS!

We manufacture
Vario-condensers and Plates

10,000 in stock.

Vario-couplers and condensers
Sliders Detectors
IMMEDIATE DELIVERIES

Wireless Service

D. S. ROSEN

147 Fourth Avenue
Corner 14th Street
New York City
Stuyvesant 6582

DEALERS

Have you tried "PRACO"
Service?

We are distributors to the trade
for all representative manufactur-
ers, and specialize in the
cutting of panels and tubing to
your order.

Have you our latest price list
and discount sheet?

**PITTSBURGH RADIO AND
APPLIANCE CO., Inc.**

Desk D

112 Diamond St., Pittsburgh, Pa.

Milwaukee

Julius Andrae & Co. are live wires—
it is generally admitted. And it's
easily proven. It's a great pleasure to
sense the thought that houses like this
one are making radio an exact busi-
ness science and to folks like this must
come a great deal of business.

The Sorgel Electric Co. had an ex-
hibit at the Milwaukee show. This
house handles a complete line and
Jack Fagan knows how to look after
his customers.

The Radio Specialty Co., with Mr.
Day as manager, offers a complete
line in their store.

The Sunlite Radio Co. plan a com-
plete set and parts.

The Radio Shop reports business
fair enough. Nice store, nice people.

One of the busy folks here is M.
Lappin, head of the Lappin Electric
Co. They're jobbers and are going to
be all set for the big Fall rush.

General trend in Milwaukee is
rather quiet. **HERB.**

RADIO AND DIVORCE

Radio is a source of annoyance to
Mrs. Elizabeth R. Tibbs, wife of J.
Fletcher Tibbs of the Southern Rail-
way, according to a petition for a
limited divorce filed in the District of
Columbia Supreme Court. Mrs.
Tibbs charges among other things
that her husband spends all his
time reading books about radio, and
all his spare money buying radio
outfits to the exclusion of herself and
child, in so far as entertainment is
concerned.

NOW MAKES TUBE SETS

The Radiophona Company, New
York City, manufacturers of the
Radiophona No. 1 crystal detector set,
are now producing non-regenerative
vacuum tube outfits for the trade. The
sets are mounted in handsome mahog-
any cabinets, 7 1/8 inches square, six
inches high, with a bakelite panel. The
company has contracted to use the
Fada rheostat, socket and switch on
all its vacuum tube sets.

NEW RADIO SHOP

The Radio Shop, Inc., of Brockton,
will open at 10 Belmont street, next to
Hotel Belmont, soon with a line of radio
and electrical apparatus. The corpora-
tion was formed July 5 with a capital
of \$10,000. R. Warren Jones is presi-
dent; Louis F. Eaton of the C. A. Eaton
Shoe Co., treasurer; Miss Margaret J.
Corcoran, clerk.

Mr. Jones is a radio engineer with
much naval wireless experience. He had
charge of the Panama Canal zone sta-
tions during the war and has been con-
ducting the Brockton Radio school in the
City Theatre block.

Solder Your Connections



for best results. Get the "Wonder" a Self Heating Iron.
Use it anywhere without stove. No workshop complete
without it. Cheap to operate. Generates own vapor in two
minutes. Absolutely safe—a child can operate. Nothing to
get out of order. Use it as a blow torch also. Boxed com-
plete with solder, salamoniac and full soldering directions.
Send No Money—just your name and address on a post card.
When the postman delivers, pay him \$2.50.

Dealers—a big seller, write for proposition.
North Shore Radio Works, Dept. C-601
810 Davis Street, Evanston, Ill.

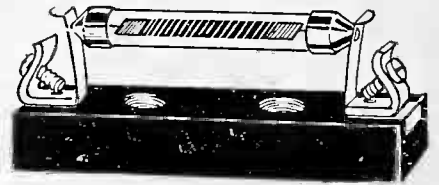

PRECISION

GRID LEAKS AND MOUNTINGS

Resistance ranges from .05 megohms
to 5. megohms. Accuracy guaranteed.
Grid Leaks 75c
Mountings 35c

Radiophone Equipment Co.
45 New Street Newark, N. J.

FROST-FONES



No. 162
2000
Oium Set
\$5.00

No. 163
3000
Oium Set
\$6.00

Ideal Receivers
for use with
Home
Radio Sets

Combine maxi-
mum efficiency
with permanent
sensitiveness

Write, wir. or phone your nearest Dealer or Jobber
HERBERT H. FROST
National Factory Distributors
to the Electrical-Radio Jobber
154 W. Lake St. CHICAGO

**BRACH
vacuum
LIGHTNING ARRESTER**

The Instrument That Satisfies
and Protects Your Customers

Brach Vacuum Lightning Arresters have a
record of performance over a period of 16
years. Big railroad, telegraph and telephone
companies rely upon it. New York and other
big fire alarm systems are equipped with it.
The United States Army uses it. Skilled radio
engineers specify it. It is listed by the Under-
writers' Laboratories.



Can Any Dealer Afford to Be Without the
Brach Arrester?

Trade Supplied by Leading Jobbers in
Radio and Electrical Supplies

L. S. BRACH MFG. CO.
NEWARK, N. J.

16 Years Specialists in Lightning Protective
Apparatus.

Makers of Solderall—Mends Metals
Connects Wires.

Trade Mark Changes

"Spare That Trade Mark" Is Expert's Advice

By CHAUNCEY P. CARTER

It is surprising how many trade-mark owners do not know of just what their trade-mark consists or what it comprises. Many of them will tell you that their trade-mark consists of a certain number of different elements and yet when you come to examine their literature, labels, packages, etc., you will often find that no two of them show the trade-mark in exactly the same way. Thus, for instance, you will find many firms using on some goods or on some wrappings or labels a combination of a word and a figure as for instance the word "elephant," while on other goods or other wrappings they will use only the word "elephant." Other firms have several elements as for instance a representation of an eagle, perched on a globe, with initials on the globe.

When it comes to registration, however, the Patent Office will not permit variations or alternatives and will insist that the applicant point out just what features are essential to the trade-mark. This is often difficult for the trade-mark owner to do with the result that he is usually compelled to file several applications to cover the different forms of the trade-mark. This is uneconomical, however, particularly when it comes to foreign trade-mark registrations where the expense runs rather heavy. It is also confusing to customers when the trade-mark is not standardized and promotes confusion between the goods of different makers.

Every actual and prospective trade-mark owner should carefully consider what his trade-mark is to be and should then register it and use it at all times accordingly. This will not only be money-saving but will help to fix the mark firmly in the mind of the trade and the ultimate consumer so that the passing off of imitation goods for the genuine will be made extremely difficult if not impossible.

Some advertising agents will say that such and such a trade-mark needs to be rejuvenated and will proceed to select one feature of it and dress it up "a la mode" leaving out many of the original essentials. In one out of a hundred cases this may be justified, but for the most part it is a dangerous thing. Rejuvenate the package or label, if you will, but manufacturer: "Spare that trade-mark!"

Copyright, U. S. A. and Abroad, 1922, by Chauncey P. Carter.

ATWATER KENT RADIO APPARATUS

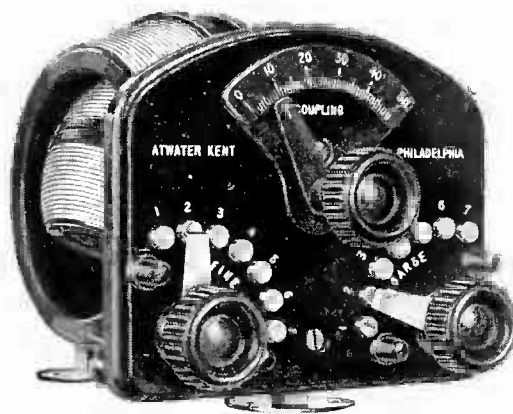

Variocoupler With Panel

A UNIQUE design developed in the Atwater Kent Radio laboratories and manufactured complete in this plant.

The unusual design and finish of this unit will appeal to every radio enthusiast who appreciates quality.

New units are constantly being added to the Atwater Kent line.

Before buying new stock, write for latest literature.



TRANSFORMER

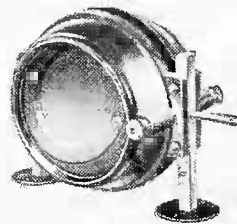

VARIOMETER

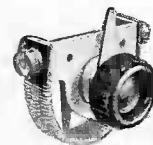

RHEOSTAT

ATWATER KENT MFG. COMPANY

4941 Stenton Avenue Radio Department Philadelphia, Pa.

JOBBER—DEALERS

ATTENTION

Radiophona No. 2

CHEAPEST AND BEST **VACUUM**
\$20.00 TUBE SET

IN MARKET

Cabinet, Mahogany. Size, $7\frac{1}{8}$ x $7\frac{1}{8}$ x 6 inches. Panel, Bakelite, Nickel Trimmings. Equipped with Famous FADA Rheostat, Socket and Switch.

SHARP TUNING QUALITIES and Range are features of Radiophona No. 2.

DELIVERIES IMMEDIATE
LIBERAL DISCOUNTS
to Jobbers and Dealers

We can make immediate deliveries on our famous Radiophona No. 1. Most efficient and complete crystal set on market. \$32.50 includes Aerial Equipment and Mesco Double Head Sets.

MADE BY

M. P. RADIO CO.

453 W. 53rd St. New York City

BEFORE you adopt a trade-mark

Have the Radio Dealer Trade-mark Bureau give you a report on its novelty based on registrations in the Patent Office AND IN THE RADIO DEALER TRADE-MARK BUREAU.

AFTER you have adopted a novel trade-mark Register it at once in the

RADIO DEALER TRADE-MARK BUREAU

4907 Potomac Ave., N. W.
Washington, D. C.

JENKINS RHEOSTAT CAREFULLY MADE

"The necessity for a rheostat that would give finer adjustment than any on the market was soon realized after radio got well under way. The advent of Radio frequency emphasizes this still further," says J. E. Jenkins, of Chicago, an inventor and radio engineer.

After giving considerable time to this very important necessity in radio Mr. Jenkins worked out the first Vernier rheostat and the immediate improvement that this invention gave to the selectivity of receiving sets, set up such a demand for this rheostat that Mr. Jenkins placed orders for large quantities and is now selling them under their firm name, J. E. Jenkins (Not Inc.).

The principle of the rheostat is a wire wound around a solid horn fibre drum in which screw thread has been cut. The wire lies in the bottom of the cut. Contact is made by a pointer attached to the shaft of the rheostat and by turning to right or left the resistance can be lessened or increased as desired, with infinitely small resistance variations.

One of the most attractive features of the Jenkins rheostat is the fact that instant contact can be made by means of a switch connection which is part of the rheostat. By simply pushing the knob the circuit can be broken, and when the filament current is again required, a pull on the knob connects the circuit and the filament is heated at the same resistance as when the circuit was disconnected. This is a big advantage and saves considerable trouble by not having to continually readjust the rheostat every time one gets ready to use the set.

"SEABOARD" STARTS

The Seaboard Radio Corporation, located at 266 Grand Street, New York City has offered to the trade their first of a line of high-grade variable condensers. It is the 23 plate variable for panel mounting with a tested capacity of .0005 micro-farads. All details have been perfected to such an extent as to make it the most popular condenser on the market. There are several improved features such as special positive contact shaft bearing, heavy gauge polished aluminum plates, precision spacing of stationary and rotary plates, and heavy top and bottom insulating plates of Radion.

The most remarkable feature of this high-grade condenser is its extremely low price, the list price being \$3.00. Inquiries of jobbers, dealers and manufacturers of sets are invited.

IMMEDIATE DELIVERY

CABINETS—	PANELS—
Imitation Mahogany or Flemish Oak Finish	Genuine Formica, $\frac{3}{16}$ " thick
6 x 7 x 10	6 x 10 $\frac{1}{2}$
6 x 7 x 13 $\frac{1}{2}$	6 x 14
6 x 7 x 20 $\frac{1}{2}$	6 x 21

Other Sizes to Order

COMPLETE RECEIVING SETS

Jobbers and Dealers
Get Our Discounts

THE MIHO COMPANY

8 East Third St. Cincinnati, Ohio

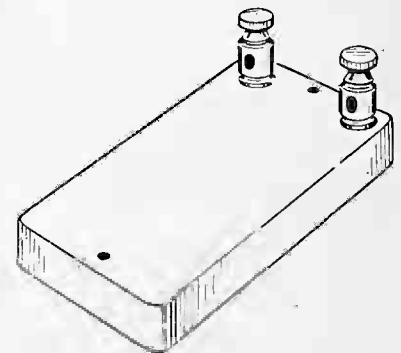
Attention Radio Dealers and Jobbers**40 and 10**

Serco Fixed Condensers,
moulded, 70 cents

Serco Fixed Condensers,
moulded, 90 cents

Serco Crystal Detector, \$1.25

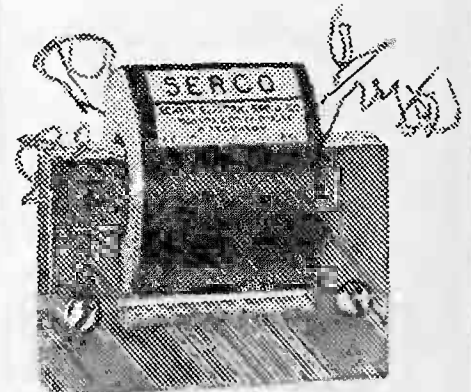

Serco Amplifying Transformer, 10 to 1 ratio, \$3.50

We are Manufacturers
of
Serco Radio Products

Write us about that special 40 and 10

Scheib Elec. Radio Co.
6243 Station Street
Pittsburgh, Pa.

Binding Post Firm

Eby Company Specializes in This Branch of Parts

The H. H. Eby Manufacturing Company, 605 Arch Street, Philadelphia, have added another design to their line of metal Binding Posts.



This new style is the same in all respects as the type they are now marketing, with the exception that instead of having a tapped base to take a standard machine screw, it has a solid threaded stem.

It is made in three sizes, and is known to the trade by the code words Sergeant "SS," Buddy and Midget; the first $\frac{1}{2}$ " diameter with $\frac{1}{2}$ " x $\frac{10}{32}$ stem; the second $\frac{3}{8}$ " diameter with $\frac{3}{8}$ x $\frac{6}{32}$ stem and the latter $\frac{5}{16}$ " diameter with $\frac{3}{8}$ x $\frac{4}{36}$ stem.

This design permits the posts to be mounted more quickly, by simply screwing a hexagon nut on the stem.

The above company advises they are now in production on all the sizes mentioned.

VERSATILE TUNERS

The Columbia Radio Laboratory, of Dorchester, Mass., are the manufacturers of a tuner with primary and secondary inductance contact in a polished mahogany box, suitable for either crystal or tube detectors. They also make an improved variometer and vario-coupler so designed as to ensure exceptionally fine tuning. This instrument is the result of two years of experimentation, and the manufacturers feel that it is a perfected product.

Other items in the Columbia line are unit control, detector and amplifier controls.

"AIROPHONE" SET

A radio receiver complete with head phones is manufactured by A. W. Bowman and Co. under the trade name of "Airophone." The set is neat in appearance, the crystal being mounted on the outside of the cabinet, making it easy to get at for adjustment and replacement.

The battery is also on the outside of the cabinet to operate the buzzer.

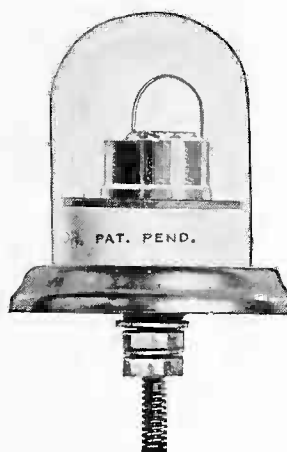

(Actual Size)

STATIC WON'T BOTHER YOU NOW

IN USING

THE "GREWOL" RADIO DETECTOR

All Troubles Are Eliminated
This Detector Is Always Set and Ready

LIST PRICE, \$2.00

Write for Proposition.

RANDEL WIRELESS CO.

9 CENTRAL AVENUE, NEWARK, N. J.

Sole United States Distributors

NATIONAL DIRECTORY OF RADIO DEALERS, MANUFACTURERS, ETC.

SUPPLEMENTARY SERVICE OF ADDITIONS, REVISIONS, ETC.

Sydell's Radio Directory and Service

555 SCHENCK AVENUE

BROOKLYN, NEW YORK

Sales and Advertising Depts.,

Gentlemen:—

The writer has available a Directory of 1,500 RADIO Dealers throughout the entire country, edited in CARD CATALOG form, arranged by states under cities, alphabetically under the cities.

These names are annotated to indicate wherever possible the distinction between exclusive dealers in RADIO equipment; those who handle RADIO only as a side-line, as dealers in electrical supplies, hardware stores, etc., and jobbers.

This list has been compiled from information secured from City and State Chambers of Commerce, current RADIO periodicals and newspapers having RADIO Departments, and contributions from Manufacturers, Dealers, Jobbers, etc.

The price of this CARD CATALOG list of 1,500 names is \$45.00, including a double cabinet with rod attachments, postage prepaid.

If so desired, this same list can be supplied on SHEETS at a cost of \$30.00.

A supplementary service of additional names, revision of old names, etc., can be supplied at a nominal charge.

A list of manufacturers of general and special RADIO supplies and equipment, arranged alphabetically by items manufactured, etc., is in preparation. If you wish to be included in this Manufacturers' Directory, please send your catalogs or other data. This will not obligate you in any manner.

Very truly yours,

N. M. SYDELL.

RECEIVERS REWOUND AND REPAIRED

Any make, copper wire, any resistance
Work guaranteed
Commissions to Dealers

MONTCLAIR RADIO CO.
272 Bloomfield Avenue Montclair, N. J.

AEREX King of the Air

COMBINATION RECEIVING SET
CRYSTAL—DETECTOR—TWO STEP

Aerex Radiophone Corporation
342 MADISON AVENUE, New York City

“AERIALITE”



The Lamp Socket Aerial

Get your orders in now for “Aerialite” Instruments. Safe, sane, dependable! Simply insert in lamp socket and receive the broadcasted music. No cumbersome antennae or ground wires. The “Aerialite” is a perfect instrument in all details and is guaranteed to give perfect satisfaction. For V. T. sets, and in cities where there are broadcasting stations it may be used with satisfactory results on crystal sets.

Lists at \$2.00

Attractive Proposition to Dealers

Manufactured by

The Condenser Specialty Co.

23 Marshall Street
Newark, N. J.

New Broadcasting Stations

- ARKANSAS
Little Rock—T. J. M. Daly.
- ALABAMA
Mobile—Mobile Radio Co.
- CALIFORNIA
Hollywood—O. K. Olsen.
San Jose—City of San Jose.
San Francisco—Claude W. Gerdes.
San Francisco—Glad Tidings Tabernacle.
- COLORADO
Denver—Western Radio Corp.
Boulder—Univ. of Colorado.
- CONNECTICUT
New Haven—New Haven Electric Co.
- FLORIDA
Pensacola—Cecil E. Lloyd.
- GEORGIA
Fort Smith—Southern American.
Savannah—B. H. Radio Co.
- IDAHO
Lewiston—Ramsey & Bryant.
Moscow—Electric Shop.
- IOWA
Davenport—Radio Equip. & Mfg. Co.
Iowa City—State University.
Sioux City—Automotive Electric Service Co.
Sioux City—Davidson Bros. Co.
Waterloo—Cole Bros. Electric Co.
Waterloo—Donald Redmond.
- ILLINOIS
Chicago—Ray-Di-Co Organization.
Peoria—Brown's College.
- INDIANA
South Bend—South Bend Tribune.
- KANSAS
Salina—Watson Weldon Motor Supply Co.
- LOUISIANA
Shreveport—W. G. Patterson.
- MAINE
Sanford—Hall & Stubbs Co.
- MARYLAND
Baltimore—Baltimore American.
- MICHIGAN
Lansing—Phillips, Jeffrey & Derby.
Joplin—J. T. Griffin.
- MINNESOTA
St. Cloud—Times Pub. Co.
Hutchinson—Hutchinson Electric Service Co.
- MISSOURI
Cameron—Mo. Wesleyan College.
- MONTANA
Butte—Standard Pub. Co.
- NEBRASKA
Lincoln—American Legion.
- NEW HAMPSHIRE
Berlin—Y. M. C. A.
- NEW YORK
Poughkeepsie—H. C. Spratley Co.
Rochester—School of Music.
Waterford—Radio Engineering Lab.
- NORTH CAROLINA
Asheville—Hi-Grade Wireless Instrument Co.
- OHIO
Cincinnati—University of Cincinnati.
Columbus—Ohio University.
Wooster—Marcus G. Lumo.
- OREGON
Portland—Pacific Radiophone Co.
- PENNSYLVANIA
Phila.—Ernest C. Albright.
Lancaster—Lancaster Electric Supply and Construction Co.
Pittsburgh—Radio Electric Co.
Shenandoah—W. H. Goss.
- RHODE ISLAND
Providence—Shepard Co.

VACUUM TUBE DETECTOR \$5.50

Including complete cabinet with all instruments wired ready for use.

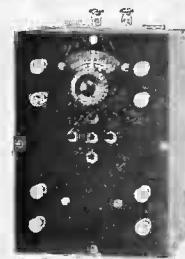

DETECTOR A N D TWO STAGE AMPLIFIER \$22.50

With transformers and all other instruments in cabinet, ready for operation. This equipment is of high quality, and distances of as high as 3000 miles have been obtained with ease.

BATTERIES AND TUBES EXTRA

2000 Ohm receivers \$5.00

SUPERIOR CRYSTAL RECEIVING SET \$4.75

Attractive dealers proposition

STEINMETZ WIRELESS MFG. CO.
5706 Penn Ave., Pittsburgh, Pa.

Ask Our Service Bureau



The EMBE Variocoupler

List Price \$4.50

Attractive Trade Proposition
Manufactured by

Marvin B. Fallgatter
Waupaca, Wisconsin

Business Opportunities

Partner or buyer wanted, who understands the radio and electrical supply business. I have a well established wholesale and retail auto supply business. Excellent location and plenty of space for the addition of a line of radio and electrical supplies. Want someone with from twelve to fifteen thousand dollars to take active interest. Partner is hopelessly ill.

Address **A. J. WINTERS**
65 Sixth St., Portland, Oregon

SOUTH CAROLINA
Orangeburg—Orangeburg Radio Equip-
ment Co.

SOUTH DAKOTA
Sioux Falls—Daily Argus-Leader.

TEXAS
Dallas—A. H. Belo & Co.
Galveston—Clark W. Thompson.
Galveston—Tribune.
Houston—Will Horwitz, Jr.
Port Arthur—Electric Supply Co.
Houston—Houston Chronicle.
Houston—Q R V Radio Co.

WASHINGTON
Everett—Kinney Bros. & Sipprell.

WASHINGTON, D. C.
Washington—Hecht Co.

WEST VIRGINIA
Bluefield—Daily Telegraph.
Clerksburg—Roberts Hardware Co.

WISCONSIN
Madison—Northwestern Radio Co.
Milwaukee—Marquette University.
Superior—Superior Radio Co.

PAMPHLET ON ARMSTRONG

The Radio Guild, 256 West 34th Street, New York, is publishing a pamphlet on how to construct the new Armstrong super-regenerative receiver. This pamphlet, which sells for 50 cents, is illustrated with twelve photographs, diagrams, and the details of the construction of two sets actually made by the author, Kenneth Harkness.

TRADE NEWS BY RADIO

Tests of the feasibility of sending foreign trade news by radiophone were made by the Department of Commerce, July 11 and 12, and the practice will be made permanent if the tests prove successful.

On those dates two gatherings of business men will be held at Boston and Baltimore; the exposition of the New England Shoe and Leather Association at Boston and import and export exposition at Baltimore. Arrangements have been made by the Commerce Department with the Navy for use of the Arlington radio station to send to the meetings the latest cabled news of foreign markets and trade opportunities received by the bureau of foreign commerce by the Department. The time of broadcasting the news will be 8 P. M. Eastern Standard time on the two days; the station Arlington (NAA) and the wave length 2,650 meters.

MAY RADIO EXPORTS

May exports of radio and wireless equipment, according to the Bureau of Foreign and Domestic Commerce, totaled \$186,525, for 92,328 articles. The total for telegraph apparatus was \$6,835 for 7,435 articles.

Shipments of telephone apparatus, including switchboards, was \$434,287.

Batteries, wire, sockets and many other items are not included in any of the above amounts.

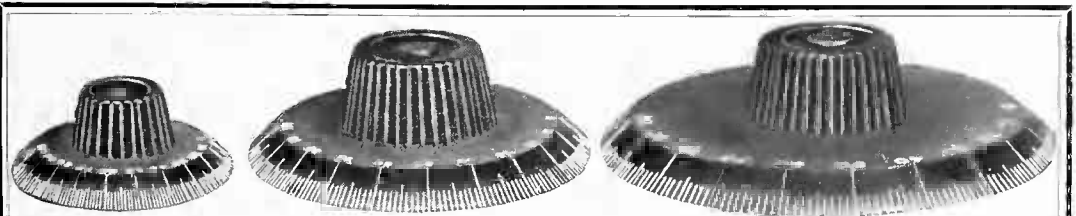

EMELOID DIALS—2"—3"—4"
2" 35c—3" 50c—4" 60c

MANUFACTURERS—JOBBER—DEALERS

WRITE FOR DISCOUNTS

EMELOID CO., INC., 536 JUNIUS ST., BROOKLYN, N. Y.

RADIO DEALERS

We Are Manufacturers of

- | | |
|------------------------------|-------------------------|
| SWITCHES | TUNING COILS |
| SWITCH POINTS | VARIABLE CONDENSERS |
| VARIOMETERS | AMPLIFYING TRANSFORMERS |
| VARIO COUPLERS | LOOSE COUPLERS |
| POST PHONE CONDENSERS | LOUD SPEAKERS |
| RADIO FREQUENCY TRANSFORMERS | CRYSTAL SETS |
| EYELET CONDENSERS | BINDING POSTS |

IMMEDIATE DELIVERY

Dealers and Jobbers — Write Us For Proposition

FORD MICA CO., INC.

15 Christopher St.

New York City

NOVO "B" Batteries



for Radio Outfits

NOISELESS—DEPENDABLE—GUARANTEED

All Sizes—Plain and Variable

22½, 45 and 105 Volts

Send for Catalogue and Discounts

NOVO MANUFACTURING CO.

424 W. 33rd St.
NEW YORK

531 So. Dearborn St.
CHICAGO

WOOD PARTS
Variometers, Cabinets, Rotors, Coil Ends,
Etc.
Mill Established 1849
Lowest Prices
THE R. C. MILLS
Executive Offices 30 E. 23d St., N. Y. C.

Condensers—Guaranteed—Tested—Perfect
Order now for immediate or fall delivery

43 plate001	\$2.00
21 "0005	1.35
11 "00025	1.10
3 "	Vernier	.80
.005 variable for Arms'rong circuits.....		6.00
Fixed Phone Grid—Grid Leak.....		.07

Special Offer to Jobbers
DUKE RADIO CO.
1758 Bergen Street Brooklyn, N. Y.

Ask Our
Service Bureau

VOLTA
PRODUCTS
ARE OF
**EXCEPTIONAL
PERFECTION**

Crystal Sets, \$7.50 List
Variometers, \$2.75 List

Volta Engineering Co.
172-4 Lorimer Street
Brooklyn, N. Y.

**GANAERITE
Detector Crystals**

Twenty years of practical mineralogy gave us the material to produce the highest quality crystal.

We are now undertaking the largest single order for mounted crystals in the market.

We individually test and guarantee to replace or refund on any unsatisfactory Ganaerite crystal.

The Harris Laboratory
26 Cortlandt St., New York City

Guarantee Crystals

**The Policy of the U. S. Radio of
Pittsburgh**

An example for radio men in other branches, as well as those in the same branch, of how to do business is shown by the United States Radio Co., of Pennsylvania, Inc., whose business address is Ferry and Diamond Streets, Pittsburgh. They sell crystals for detectors. That's only the beginning. They advertise in trade and radio fan papers to let everybody know that they have crystals for sale, U. S. Eagle Crystals.

The U. S. Radio Co. believe that their crystals are the best on the market. So confident are they in their product that they enclose a guarantee with each one. This reads: "We guarantee that each U. S. Eagle crystal is tested and sensitive. If any U. S. Eagle crystal is not satisfactory, return this slip with your address, and the address of your dealer direct to us, and receive another crystal free of charge by return mail. The U. S. Eagle trademark is your protection."

The U. S. Radio people do business in a nice way. Consequently it is not surprising to hear that they are adding to their business every day.

**RADIO AGREEMENT IN TWIN
CITIES**

The Minneapolis Tribune, the Minneapolis Journal, and the St. Paul Pioneer Press and Dispatch, in accordance with the recommendation of J. A. O. Preus, governor of Minnesota, have agreed to discontinue their individual radio telephone broadcasting stations in favor of the station of the University of Minnesota. This agreement was signed by the papers after a conference between F. E. Murphy of the Tribune, H. V. Jones, the Journal, and C. K. Blandin, the Pioneer Press and Dispatch. This now leaves the field clear for the state university.

RADIO IN SOUTH AFRICA

Various wireless telegraph schemes are now occupying the attention of the Government of the Union of South Africa. The British Imperial Government has a scheme of connecting Great Britain and South Africa by a series of short range stations via Cairo and Nairobi, which will involve the expenditure on the part of the Union Government for its station of approximately £180,000. Under this scheme the range of the South African station is to be between 2,000 and 2,500 miles.

Du Kane
Variable Condensers
All Metal
High Capacity

43 }
23 } **Plate Sizes**
17 }
11 }

Immediate Shipment
Any Quantity

Duquesne Radio & Mfg. Co.
6426-28-30 Hamilton Ave.
PITTSBURGH, PA.

Ask Our Service Bureau



**RAY-O-VAC
"B"
BATTERIES**

*in 22½, 45 and
100 Volt Sizes*

1. The individual cells are noiseless throughout their entire life.
2. Cells are rigidly held.
3. All connections are positive and permanent.
4. Each cell is thoroughly insulated.
5. Batteries are compact and waterproof.
6. Special spring clip terminal.

Your customers deserve the best "B" batteries. Ray-O-Vac Batteries are made by the same experts who have made French Ray-O-Lites famous for quality.



*Write for Bulletin
225 and prices.*

**FRENCH BATTERY
& CARBON CO.**

MADISON, - - WISCONSIN

Chicago	New York
Minneapolis	Dallas
Atlanta	Kansas City
	Denver

French RAY-O-LITES
and
Dry Batteries

Newspapers Scare

Eagerly Print "First Radio Accident" Without Investigation

The metropolitan daily newspapers scented a startling story in the report that a fire had been caused by an amateur radio set and they "played it up" in startling headlines.

At the height of one of the recent thunderstorms in New York a bolt of lightning, it appears, struck the radio apparatus and fire ensued.

It developed that the rubber insulation covering the aerial from the arrester to the set was completely burned out. No harm came to the ground wire.

Examination of the set after the lightning and after the slight fire had been extinguished found the outside aerial and the roof antenna in good condition.

Some of the newspapers printed the "scare" story without investigation.

Radio experts were amused at the inaccuracies that were printed and wanted to know why the "radio editors" had not been consulted.

Dr. Alfred N. Goldsmith, professor of electrical engineering at City College, regarded the occurrence as "almost a phenomenon," and expressed the belief that a heavy bolt of lightning penetrated the porcelain-shelled arrester and struck the inside aerial. Another explanation offered by experts is that the ground wire which connected with a water pipe was not properly adjusted.

At any rate, the newspapers "spoke out of their turn" and it certainly interested their radio advertisers.

FILM RADIO MAKING

The *New York Tribune*, by arrangement with the United States Bureau of Standards, has arranged for the production of the film, "How to Make Your Own Radio." This shows the construction of a radio receiving set by a fourteen-year-old boy. The instructions followed by the boy are those issued by the Bureau of Standards. These same instructions are to be printed, so that any boy can do what the boy in the movie does. The set designed is a simple form of crystal detector set. Erected in and around New York, it will enable you to hear the concerts sent out from Newark, Bedloe's Island and other local broadcasting stations. The Bureau of Standards announces that it has built one of these sets, and tested it, finding it has a range of twenty-five miles for reception from high-powered stations. It can be built at a cost of between \$6 and \$10.

Immediate Delivery

Variometers
Vario-Couplers
Panel Mounted
and
Unmounted



Vacuum Tube
Detector
and
Amplifier
Panels

DEALERS—Simplex Products Move Fast

JOBBERS—Place Your Orders at Once

SIMPLEX RADIO CO.

1013-15 Ridge Avenue

Philadelphia, Pa.

COMPRESSED, BAKED, SEALED

KAPACITON

INDIVIDUALLY TESTED

KONDENSERS

ARE BETTER CONDENSERS!

Phone * Grid * Grid with fixed leak * Grid with detachable and variable leak. (Pat. Pen.)

**A CUSTOMER—FOR—ONCE or
"FOR KEEPS" . . . ?**

It's entirely in your hand to have either sort—the customer who comes once and swears "NEVER AGAIN," or the customer who enthusiastically keeps coming and grows into a valuable asset.

Dealers tell us KAPACITONS make repeat customers. Certainly, they build a buyer's confidence in you. To begin with, a KAPACITON is a technical product, not a toy or a makeshift. We've been making the best electrical insulations over a decade. We make the best condensers now and

When better ones are made, we'll make them

KAPACITONS have positive contact through continuous copper foil, UNIFORM CAPACITY through being compressed to a definite thickness, PERMANENT CAPACITY through being baked and sealed; KAPACITONS are individually tested. They improve reception and eliminate those noises which are directly caused by a loosely wound condenser without continuous foil. KAPACITONS are moderately priced and allow the dealer a fair profit.

That's why they are

SOLD BY THE BEST JOBBERS AND DEALERS!

Meironsky

Established 1910

Jersey City, N. J.

BUY DIRECT

for greater profits

ROGERS RADIO RECEIVER

Type B, complete short wave tuner detector and two stage amplifier in mahogany cabinet, no jacks, rear connections, list \$60.00. Liberal discounts.

Rogers Radio Co.
5133 Woodworth St. Pittsburg, Pa.

NEW MAGNET WIRE

Antenna wire made up of fine hard drawn copper enameled wires twisted together is made by the American Enameled Magnet Wire Company of Muskegon, Michigan, under the trade name of American Enameled Litz Antenna Wire.

It is said to have a very low resistance to high frequency currents, furnishing great conducting capacity. The enameling prevents corrosion, thus resistance does not increase rapidly shortly after installation, as is the case with bare copper. American Enameled Litz Antenna wire is similar to "Litzendraht" magnet wire used in coils of the United States Navy instruments.

for three years

We have been engaged exclusively in the manufacture of high grade radio apparatus.

Year by year experience has enabled us to improve our products.

Year by year we have built up an organization of trained radio men and skilled mechanics.

Year by year we have added to our factory and laboratory equipment.

Now, in the high quality of WILCOX RADIO APPARATUS you receive the results of these years of advancement.

We manufacture receiving sets, amplifiers, unit panels, and a complete line of standardized parts including rheostats, sockets, variometers, jacks, plugs, switches, etc.

We shall be glad to get in touch with a few more good dealers and jobbers. Write for literature.

The Wilcox Laboratories
LANSING Dept. L MICHIGAN

Out with the Fakers

(Continued from page 22)

promotions are likewise being handled from the down-town section of New York. Not all of the Wall Street flotations are bunk—but taking the total of the recently incorporated radio companies, one wonders at the total. The billion mark is in sight for radio incorporations.

Most of the radio stock is being sold via salesmen, rather than by newspaper advertising—because many of the States have sensible laws anent advertising fake stocks.

This is the time to circumvent the fakers and it can be done if the honest men in the industry will devote a little time and thought to the matter.

Every time you receive a "radio stock circular" and are dubious about its promises lodge an inquiry with the Post Office Department at Washington. This department will investigate.

If it's a local firm pass on the query to your district attorney or police department. This will often bring results.

If you see a promotion advertised in a newspaper or magazine ask the publisher to approve of the stock. If he refuses go right ahead and complain to the post office or to the district attorney.

Nip the money-suckers in the bud and every one in the radio industry will be benefited.

It might be possible to broadcast talks against fake stock promotions. This would be an unusual way to protect the people, of course, and while the broadcasting folks wouldn't care to "mention names" a daily warning on not buying radio promotion stocks would be of good service.

These broadcasting stations ought to advertise their hearers to consult their bankers before buying radio company stocks.

Honest concerns will not fear scrutiny—the others have no right to exist.

Meanwhile, let each one of us do something to thwart the fake radio stock promoters. Let us do it as individuals, until such time as the radio industry has a strong national body to fight its battles.

Show no compassion, radio tradesmen, to the fake stock promoters. They deserve only extinction and we can all do our share to rid the land of these sharpers.

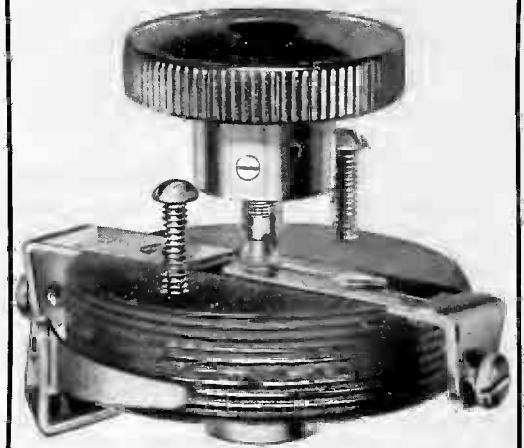

TYPE A

Capacity 2 amps. Total Res. 12 ohms.

JENKINS VACUUM TUBE RHEOSTAT

List \$1.75

WOW BOYS it's a "PIP"
It's The RHEOSTAT
THAT-PUT-THE
"R" in RADIO

COME ON, you live RADIO DEALERS. CASH IN on this NUMBER.

IT'S SO GOOD, I've had a nice Circular printed in blue ink, on expensive blue paper, cost me a lot of money—but what do I care, I'm making a lot of money, selling RHEOSTATS.

The Circular tells you all about it.

WRITE ME for a Circular. IT'S FREE.

Dealers discount 30%.

JOBBER—YOU'RE IN ON THIS, TOO.

WRITE and Ask ME

JENKINS RHEOSTAT eliminates head phone noises.

It can be cut in and out without changing the setting.

Those who have used this Rheostat say they will never operate a set without it. It makes plate and grid potentiometers entirely unnecessary.

**Now That Everything Is Clear
LET'S GO**

Distributingly yours,

A. H. REDDEN
IRVINGTON, NEW JERSEY

P. S.—Don't Blame The "EDITOR"
I Write All Ads Myself

Radio's Place

If Made Ornamental Has Place in Home

What is believed to be one of the most elaborate radio receiving sets is now being manufactured by the Mercury Radio Corporation of New York City. This firm is making sets that retail from \$25 to \$600 complete.

The \$600 set is contained in a mahogany cabinet that is inlaid with rare woods with the skill representative of artisans' best handicraft. No minute detail has been overlooked to make these cabinets second to none in performance. As an added feature these sets contain a talking machine in addition to the radio receiving sets.

An officer of the Mercury Radio Corporation in an announcement to the trade says "that the public is seeking radio receiving sets that will actually perform, and in addition the sets must be ornaments to the home—and we have combined both. Radio has a place in the home—but it must beautify it."

BIG PRODUCTION

General Insulate Co., Brooklyn, N. Y., the well known moulders of "Insulate" and "Hi-Heat" composition, with a complete line of standard "Insulate" Knobs, Insulators, Binding Posts, Head Set Caps and Bases, Variometer parts, etc., for radio purposes, have been running to full capacity and overtime for many weeks past, to meet the demands made upon them by their hundreds of customers the country over for quantities of these "Insulate" products.

General Insulate Co. has an immense output and has been able to give service, as scores and scores of their customers testify, that such customers have been unable to get elsewhere.

In the month of May the shipments of this company were 500 per cent greater than January, 1922. This is certainly a splendid evidence of progress.

FOR THE FRENCH ONLY

Hart O. Berg, who said he was associated with Lewis Nixon, sailed for Europe last week and as he sailed he declared he was taking with him an American radio invention which he prophesied would revolutionize the trade. It is a radiophone which he described as being self-contained and without ground wires or antennae. Mr. Berg said the device, backed by American capital, would be marketed in France.

RADIO CABINETS

WE MANUFACTURE A COMPLETE LINE OF RADIO CABINETS, OF MAHOGANY, WALNUT, OAK, AND WHITE WOOD, IN ALL SIZES, AND IN ANY FINISH. BEST OF CONSTRUCTION. DIRT, DUST AND MOISTURE PROOF. QUICK DELIVERIES—QUANTITY PRODUCTION PRICES. SEND US YOUR SPECIFICATIONS, OR A SAMPLE OF YOUR CABINETS, AND GET OUR PRICES.

CABINET WORK SINCE 1900

ESHOO CABINET WORKS

635 HERKIMER ST. TELEPHONE
BROOKLYN, N. Y. LAFAYETTE 2324

Prompt Shipment—when you want it!

Send for *Special Discount Sheet* on

PARAGON SETS and PARTS—HOMCHARGERS
—DeFOREST SETS and PARTS—PRESTO-LITE
BATTERIES—No. 1250 HONEYCOMB COILS—
No. 1500 HONEYCOMB COILS

also

our own "FERA" PRODUCTS

Immediate delivery on BAKELITE PANELS cut to size.

Send us your inquiries for anything. Try our service and be convinced.

Address Department E

Federal Radio & Electric Company
41 PARK AVE., PATERSON, N. J.

TONKS VARIABLE CONDENSERS

Every condenser tested before leaving factory and guaranteed to function properly

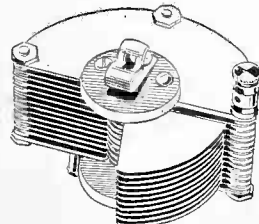

Air Type

13 plate—.00025—\$3.00
23 plate—.0005—3.50
43 plate—.001—4.25

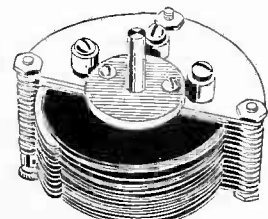

Insulated Type

Ideal for Amateurs
13 plate—.0005—\$3.40
25 plate—.001—4.00

Distributors Write

Only One Wanted in Each Territory

TONKS MFG. CO.

16-22 BOYDEN PLACE
NEWARK, N. J.

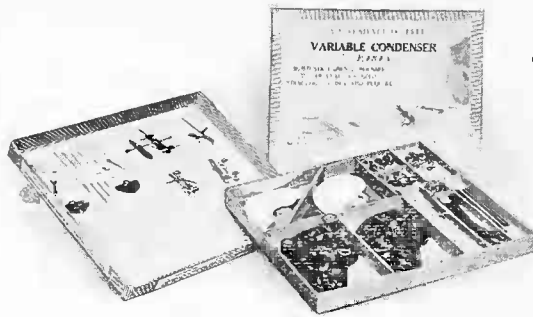

Showing 17 plate condenser, neatly packed, in handsome container which is sure to make sales for you. Inside cover showing directions and diagrams for easy assembly

DEALERS

Build Your Profits
as Your Customers
Build Their Con-
densers

Competition is going to be keen in Radio this fall. The dealer who appeals to the natural human instinct to build, and to the universal desire to save money, will profit most.

FEATURE

MARSHALL Variable Ready-to-Build CONDENSERS

Actually scientific instruments, prepared so radio amateurs can set them up. No especial skill or mechanical knowledge required. The experimenter can build his condenser to suit the exact capacity requirements of his own set. PLATES CANNOT GET OUT OF TRUE.

Rapid Turn-over Assured. Use the above Talking Points and Watch Them Make Sales for You!

STANDARD SIZES—RETAIL PRICES

No. of Plates	Price, Assembled	Price, Ready to Build	No. of Plates	Price, Assembled	Price, Ready to Build
3	\$2.50	\$1.90	23	\$5.25	\$3.80
5	2.75	2.10	35	6.00	5.15
9	3.50	2.55	43	6.50	5.80
17	4.25	3.35	67	10.00	8.40

NOTE:—Marshall Condensers are not offered as competitors to cheap condensers. They are priced directly in line with condensers of equal capacity and quality.

Liberal dealer discounts. For full particulars address

NEW HAVEN RADIO COMPANY

MANUFACTURERS

441 Chapel Street,

New Haven, Conn.

LATEST and MOST POPULAR

Radio Books

- Radio Hook-Ups**, by M. B. Sleeper.....\$.75
An indispensable book to the radio amateur who designs or builds his own receiving apparatus.
- Radio Design Data**, by M. B. Sleeper..... .75
A book giving tables and data for designing receiving and transmitting apparatus.
- Construction of New Type Trans-Atlantic Receiving Set**, by M. B. Sleeper .75
Tells how to listen to the high-power telegraph stations of foreign countries.
- Construction of Radiophone and Telegraph Receivers for Beginners**, by M. B. Sleeper..... .75
Tells in detail the building of radio apparatus.
- How to Make Commercial Type Radio Apparatus**, by M. B. Sleeper.. .75
Describes in detail many commercial types of transmitting spark and vacuum tube sets, both telephone and telegraph and receiving equipment of all kinds.
- Wireless Telegraphy and Telephony Simply Explained**, by A. P. Morgan..... 1.50
A book the Radio experimenter cannot afford to be without.
- Experimental Wireless Stations**, by P. E. Edelman..... 3.00
A book describing all modern improvements.
- A B C of Vacuum Tubes Used in Radio Reception**, by E. H. Lewis... 1.00
A book explaining in detail all about vacuum tubes.

FREE! Catalogue of Wireless, Automobile and Other Books Sent Free on Request

The Norman W. Henley Publishing Co.

2 West 45th Street, New York

Liberal Discount to Supply Houses. Write for full particulars and dealer's proposition.

“Ask Our Service Bureau”

Just a Bit About the Organization Behind the Service

By B. B. STERN

Manager, The Radio Dealer Service Bureau

Readers of this publication have seen this oft repeated injunction, “ask our Service Bureau” shoved in between advertisements numbers of times, and hundreds of radio firms have availed themselves of the opportunity and asked, not once but several times.

One or two of the problems put up to this bureau have been hard to solve. Some requests for the name of manufacturers using a particular trade mark have been regretfully returned as “unknown,” while some of the technical inquiries have had the best brains of our technical editors busy for quite a while.

Other requests from export houses for certain goods at certain prices have been unsuccessfully handled because prices would not come down so low, but all in all the *Service Bureau* has served, and served the trade quite well.

Some idea of the class of inquiries handled can be gathered from one day's inquiry chart.

Two requests for prices on a general line.

A telephone call for the address of the maker of a well-known vacuum tube.

A request for a list of manufacturers of variable condensers.

Three requests to be listed as makers of various lines of equipment.

An export house in the market for five thousand telephones.

A letter to be forwarded to the patent holders on a well known hook-up.

A rush order for a well known brand of loud speakers.

An experimenter who wanted addresses of makers of seven items, one list of which included nearly fifty names.

The same experimenter looking for a work shop, and to finish the day, nearly a score of requests for names of buyers listed in the *Weekly*.

The *Service Bureau* works for the industry as a whole, without cost or charge to anyone.

Manufacturers who are not already listed in this bureau should write at once, outlining exactly what they make.

Anything you want—“Ask Our Service Bureau.”

Book Review

By **BERNARD JEROME FARRELL**

The Editors of the *RADIO DEALER* will be glad to review new publications in this field as they may be issued. Address them attention **BOOK REVIEW EDITOR**, the *RADIO DEALER*, 1133 Broadway, New York City.

THE RADIO TELEPHONE HANDBOOK, by H. G. Cisin, M. E. Published by The Allied Engineering Institute, 1400 Broadway, New York City. \$1.00.

This book contains practical and useful facts about radio and is of interest from cover to cover. It contains no vague theories or technical discussions, being written as a thorough survey of present-day radio receiving requirements. The first chapter tells in a simplified and understandable way just how radio works. Radio telephone receiving apparatus is next discussed. Crystal detectors, vacuum tube detectors, telephone receivers, tuning devices, aerials, grounds, etc., are taken up in detail. The chapter on installation and operation is unusually complete and contains tables of faults and remedies as well as a number of useful hints on installation, operation and maintenance. Dealers and others who expect to go into the radio game in a commercial way will find the chapter on merchandising especially valuable. The last chapter is devoted to a complete dictionary of every-day radiophone terms. The appendix contains a list of radio parts which dealers should stock as well as the latest underwriter's requirements in regard to radiophone installations.

Among the features of interest to radio fans discussed in this book are "What Determines the Length of the Aerial"; "How Best to Protect Against Lightning"; "Which is Preferable, a One or a Four Wire Aerial?"; "Why Some Radio Sets are Simple and others are Complicated"; "What Batteries if Any are Necessary?"; "When an Indoor Aerial Can Be Used"; "Under What Circumstances Ground Connections May be Dispensed With"; "When a Loud Speaker May be Used"; "Whether a Vacuum Tube May Be Used in Conjunction With a Crystal Detector"; "Whether More Than One Radio Receiving Set May Be Connected to the Same Aerial"; "How to Check Up the Condition of the Storage Battery"; "When Shielding is Required"; "How to Eliminate Howling"; etc.

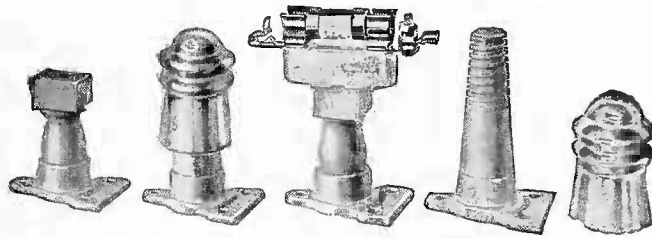

X-RAY INSULATOR ADAPTER

fills a long felt want for a lead in insulator—approved, up-to-date, complies with every regulation, both national and local, made in two styles—one for lead in, one for lightning arrester.

Aeroplane Wire

19 Strand Silicon Bronze Aerial Wire. Each strand (tinned.) Guaranteed to give 100 per cent satisfaction. This wire was used during the war by the U. S. Government for aeroplane and trench work and was the only wire to stand up under these conditions.

We have the entire supply and are prepared to make immediate shipments.
Cory Phones 2000 Ohms Connecticut Phones 3000 Ohms Turney Phones 3000 Ohms

Liberal Dealers' Proposition

HINTZE BROS., Inc., 459 Central Ave., Newark, N. J.

McTIGHE ALKALINE STORAGE "B" BATTERY
for RADIO OUTFITS

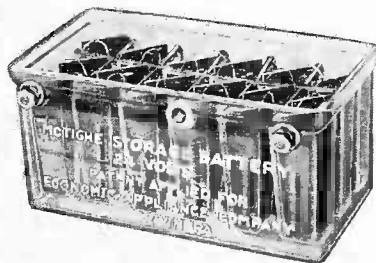

This month the McTighe Storage "B" Battery makes its appearance in an attractive oblong glass container of the unit construction type. It is the most satisfactory 22 volt "B" Battery—is inexpensive—noiseless—cannot be damaged by short circuit, overcharging, standing idle or uncharged. Can be fully charged from any light socket for less than one cent. The McTighe Rectifier is cheap, simple, durable and effective, and should be used when charging the McTighe "B" Battery.
Battery \$5.00 Rectifier \$1.50 Rubber Filler 25c
Discount to Dealers. F. O. B. Irwin, Pa.

ECONOMIC APPLIANCE CO.
IRWIN, PENNA.

MODERN
RADIO EQUIPMENT COMPANY
TRADE MARK

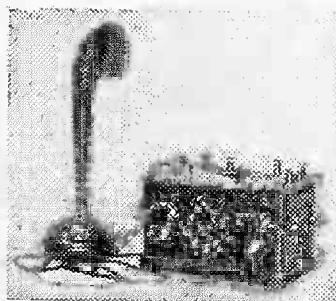

Established 1911

Territory now being allotted to jobbers and dealers desiring to handle ONLY high grade guaranteed radio equipment.

Write at once for full information.

L. P. HORNING, JR.
EXPERIMENTAL LABORATORIES

Distributors for "Modern" Radio Apparatus

ELIZABETH TRUST COMPANY BLDG.
Elizabeth, New Jersey

THE CONSOLIDATED RADIO CALL BOOK. Fourth Edition. Consolidated Radio Call Book Co., Inc., New York. 280 pp. Price, \$1.50.

The spread of Radio to every nook and cranny of this little world is evidenced by the popularity that this book has already attained and will attain. Two years ago it would have interested only the professional. Today, with amateurs able to talk to Scotland and with general conversations by Radio with passengers on transatlantic liners not a very distant event, the Consolidated Radio Call Book is of interest to anybody interested in Radio. One might even go so far as to say "essential."

Within its 280 pages is crammed information about Radio the world over. More than 15,000 ships are listed with Radio equipment. There are two listings, one alphabetically according to the name of the ship, the other alphabetically according to the radio call. The fascination of talking with sea vessels is thus made easy for the radio amateur, provided he has a strong enough wave length.

Or he may wish to communicate with his fellow enthusiasts on dry land. The Consolidated Radio Call Book lists in its present issue more than 16,000 Radio amateurs and their stations throughout the United States

and Canada. The listing is according to geographical location and radio call. The address of the station is given in each case.

The completeness of the book and its thoroughness are indicated by the examples given above. It lists the high power stations of the world from the 17,300 wave length government station at Annapolis to the one in Stavanger, Norway, and the one in Sayville to the British station in Singapore.

In the book are also listed broadcasting stations, Radio compass stations, and United States special land stations. There are also seven two-color maps showing the location of high-power stations the world over, as well as a map showing the division of the United States into Radio districts.

A glance through the book is breath-taking, so vast, so broad is the sweep of Radio. It deals in continents, and that is not the least part of its fascination.

The Consolidated Radio Call Book catches the spirit of Radio. It is a compendium in every sense of the word.

"WWJ, The Detroit News." The Evening News Association, Detroit, Michigan. 96 pages.

One of the first newspapers in the

United States to establish a broadcasting station, "The Detroit News," or WWJ, as it is known to Radio fans from Alberta to Albuquerque, has once more displayed its enterprise by publishing the little volume bound in neat gray covers.

The book tells of the Radio activities of the Detroit newspaper since August, 1920, when the "News" first installed a transmitting station and began to broadcast regular programs. The last half of the book contains valuable information on Radio, the two styles of sets, list of broadcasting stations, and a comprehensive list of Radio definitions.

PITTSBURGH RADIO DAY

"Pittsburgh's Radio Day" designated by the Radio Engineering Society of Pittsburgh to take the place of the usual annual outing will be held in West View Park on August 24th. Its attendance will not be limited to club members and their friends alone, but will be open to everyone in Pittsburgh who desires to come out and enjoy himself in the midst of a great throng of radio enthusiasts.

Every amusement will be in full swing and will be supplemented by a "Radio" Show, demonstrations and exhibitions of various radio apparatus under the direction of prominent dealers and manufacturers. Various radio novelties will be given away free and everybody will be given a chance to take home a real radio set by carrying off some of the prize athletic and aquatic events to be staged. A special radio dance will be the feature very attractive to the terpsichorean art devotees.

One of the spacious dining halls of the park will be devoted to the exhibitors whose space is given in return for a prize donation to the outing. The demonstration will be carried on in program style allowing every dealer and manufacturer a certain portion of time in which to demonstrate the receiving qualities of his apparatus. Positively no two sets of receiving equipment will be in operation at the same time.

REORGANIZES FIRM

The Ampli-Radio Company, of Toledo, Ohio, have reorganized under the name of the Williams Radio Company, 1438 Washington Boulevard, Detroit, Michigan. The personnel of the new company is Ralph R. Williams, president; T. J. Malloy, vice-president and general manager; Earl L. Smith, secretary.

DEALERS

Full Line of Radio Supplies Most in Demand
IMMEDIATE DELIVERY

Genuine DE FOREST Apparatus

All Coils and Mountings Required for

The New ARMSTRONG Regenerative Circuit

Distributors for
BRANDES

Superior
"Matched Tone"
Phones

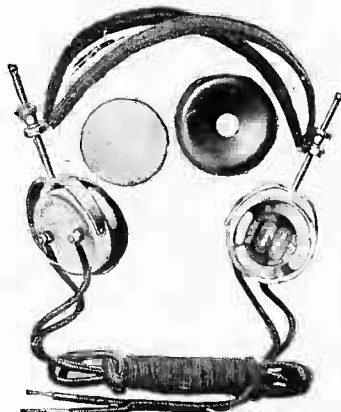

Sales Agents for
Marle Audio Frequency Transformers, used exclusively on all De Forest equipment

Stock These Profitable Items

North Ward Jacks (All sizes)

Little Wizard Detector Sockets—Single, double and triple

Wire, Phone or Write for Prices and Discounts

NORTH WARD RADIO CO., 72 Orange St., Newark, N. J.

Radio Securities
By FRANK T. STANTON

The past month has shown a gain in the value of Radio shares and not a loss as was generally expected. Radio Corporation Common stock sold at \$5 per share and Dubilier Cond. & Radio sold above 9. Canadian Marconi sold at \$3 per share and Reynold Spring held around \$45 per share. Big preparations are being made to float many new Radio concerns and further advance the prices of the already listed companies in the fall. Big money is going to be made and lost in Radio shares this winter. Be careful of the stock you pick. Consult your bank or a reliable broker.

REYNOLDS SPRING COMPANY

After reaching a high of \$51 per share the stock re-acted on Profit taking below \$45 and is now holding around \$45. Mr. Reynolds is now in New York and he states that they are well under way with their production at their Jackson, Michigan, plant. He expects big things from Radio and that his company will figure in no small way.

DE FOREST RADIO TEL. & TEL. CO.

All sorts of rumors are afloat concerning the stock end of this Company. We understand there will be changes in the management. It is too early to make any statements but it is our guess that the new directors will be closely allied with the Reynolds Spring Co. In that event both Companies should benefit. The Company has paid its second dividend of 50c. per share in three months—April 10th and June 10th.

CANADIAN MARCONI

London has been buying all the shares of this Company that were offered in America. We would not be surprised to see them make a big market in the fall in order to sell this accumulated stock.

DUBILIER CONDENSER & RADIO CO.

Shonnard & Co., members of the New York Stock Exchange, have issued a descriptive circular on this Company. Those wishing a copy of this circular should write them at 120 Broadway, New York City. This concern is a specialty company. One of their biggest sellers is the DUCON, a device which eliminates the necessity of an aerial. The stock has been selling between \$8.50 and \$9.50 on the New York Curb and it is expected to be listed on the New York Stock Exchange shortly.

ENGLISH MARCONI

This Company holds its annual meeting in August. At that time very important matters of interest to the stockholders will be discussed. People interested in this stock should watch this concern for our comment on the report of this meeting.

RADIO CORPORATION OF AMERICA

A good many people who sold their stock on the recent advance have been expecting to buy it back much cheaper during July. They were disappointed as the stock held very firm at \$4.50 until the past week when it rallied and is now selling at \$5 per share. The efficient way in which this company is managed is very evident. They are going along with their pro-

MANUFACTURERS	DEALERS
RADIO PANELS	
of Genuine XX Grade Black	
BAKELITE-DILECTO	
<p>Dealers —Let us write you about our "24 hour service" on popular size panels. This enables you to supply your customers with any quantity, without carrying a large stock.</p>	<p>Manufacturers —We are supplying a great number of manufacturers with panels, drilled, grained and engraved. Making weekly or monthly shipments according to their production schedule. Let us supply you. Send us blue print or sketch and we will submit prices and sample.</p>
STANDARD RADIO PARTS CO.	
30 Church St., Room 2013, (Phone—Cortlandt 2515) New York	

Ask Our Service Bureau

MANUFACTURERS!	
If you have not seen a copy of	
The Radio Dealer Weekly	
write for one today	
Address: The Service Bureau	
The Radio Dealer	
1133 Broadway	New York City

<p>CAP AND CASE OF MOULDED CONDENSITE</p>		<p>3000 OHMS WEIGHT COMPLETE NINE OUNCES</p>
"WESKEN"		
FEATHERWEIGHT PHONES		
Stevenson Brothers Sales & Eng. Co.		
Richland and Finance Streets		
HOMEWOOD P. O., BOX NO. 5	PITTSBURGH, PA.	
Also Manufacturers of "WESKEN" Loud Speaker Radio Receiver		

**SPECIAL
AUGUST PRICES**



Hard Vulcanized Rubber Polished Knob

**Hand Buffed—Nickel Parts
Non-Binding Bearing
500 Lots, 16c Each**



Composition Knob

**Tapered and Highly Polished
500 Lots, 14c Each**



Composition Knob

**Hand Polished and Buffed
500 Lots, 12c Each**

Further Reductions on Larger Quantities
Pink-a-tone Receiving Set Complete
\$12.50

Special Prices on Filament
Rheostats

CHAMPLIN MFG. CO.

90 WEST BROADWAY
NEW YORK

Tel. Barclay 8676 Established 1860

gram without any excitement. We believe it would be well for others going into this business to follow their example. They should realize that this is not a get rich quick business but should be a well managed industry.

NEW YORK TEL. CO. PREFERRED

The popularity of telephone and telegraph securities was very strongly demonstrated in the recent \$25,000,000 issue of 6½ per cent. preferred stock of this Company. Over 107,000 persons applied for shares, most of these people being small subscribers. The issue was three times over-subscribed. The subscription price was \$100 and the first day the stock was traded in on the New York Curb it sold at \$108.25 per share.

Stanton's Wireless Bulletin for July-August has many interesting articles. "Radio Today and Tomorrow," by David Sarnoff, General Manager of the Radio Corporation of America, should be read by every one interested in any branch of the Radio Industry. Copies can be had free by applying to Frank T. Stanton & Co., 35 Broad Street, New York City.

Stocks

	Bid.	Asked.
Amer. Marconi Stamped.....	5c.	20c.
Amer. Tel. & Tel.....	121¾	121⅞
Canadian Marconi	2¼	3¼
Cuban Tel. Com.....	60	80
Cuban Tel. Pfd.....	75	90
De Forest Radio Tel. & Tel.	5	10
Dubilier Cond. & Radio.....	8½	9
English Marconi, Common...	10	14
English Marconi, Pfd.....	10	14
Federal Tel. & Tel.....	5	6
General Electric Co.....	177	179½
International Tel. & Tel.....	52	56
Marconi Int. Marine.....	7	8
Radio Corp., Common.....	4¾	5
Radio Corp., Pfd.....	3⅞	3¼
Reynolds Spring.....	44½	45½
Spanish Marconi	1	3
New York Telephone Pfd...	107½	108

OPEN WHOLESALE DEPT.

Lyon & Healy, the noted music house of Chicago, have completed the organization of their wholesale Radio department, according to W. J. Byrnes of their publicity department. All leading lines will be handled, the company delaying the opening of this new branch of their business until they had lined up the best known firms in the Radio business for jobbing representation.

The retail Radio department at the Lyon & Healy store on Wabash Avenue, opened on July 25, and revealed a display that was both original and complete. The company will have a Radio exhibit on the Municipal Pier at the Chicago Pageant of Progress. Chas. Hindringer is manager of the Radio department.

SEEING AHEAD

The past few months we have seen a comparatively new industry start. We have seen Radio, the new marvel, rapidly developed. Ten years from now we can tell others that we were present when this started.—*Hoyt's Service, Inc.*

3000 OHM SETS, \$4.50

2000 OHM SETS, \$4.00 1000 OHM SETS, \$3.50
Plus 20c for Postage and Insurance
Satisfaction Guaranteed or Money Back



We mail phones the day your order arrives. Every pair tested, matched, and guaranteed as sensitive as \$8 to \$10 phones. We have no agents or dealers. By ordering direct you save dealer's profits—circular free.

TOWER MFG. CO., Brookline, Mass.
18 Station St.

BROADCASTS POLITICS

Use of Radio in political campaigns was instituted in Manitoba, Canada, on July 15, when Hon. T. C. Norris, Premier of the province, delivered a campaign speech through the microphone at the broadcasting station of the Winnipeg "Free Press."

The broadcasting station has a wave length of 220 meters and was one of the first in Western Canada to provide Radio programs for all within Radio distance of the station.

STEVENS

**R
A
D
I
O** **P
A
N
E
L**

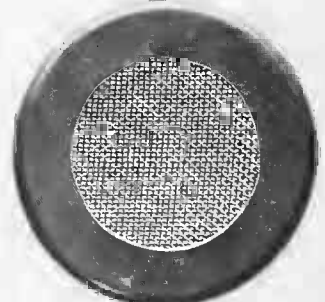

WINDOW

Patent Pending

An accessory that sells on sight. No stock complete without them. A trial order will convince you.

Business is good with dealers who handle our product. Send us a trial order and be convinced.

Has met with instant approval wherever shown. Place your order now.

A profitable, fast selling necessity without which no stock is complete.

An improvement to any panel and a necessity for every dealer. Order your supply now.

Black or Nickel Finish

Price \$1.00

Liberal Discounts

Distributors Wanted



Dept. D

434 60th Street, Oakland, Calif.

PHILADELPHIA POINTERS

By W. B. Wilkinson

Durham and Company, radio engineers, have moved to new quarters at 1936 Market Street, where they are broadcasting under call letter WCAU. The firm has produced and is ready to market, a high grade line of sets and parts.

The General Radio Service Corporation, at 19th and Market, are about to put on the market a new set with patented features. They are sole distributors for Kelco batteries.

The Machen Electric Co., of Bridesburg, are ready to market a complete line of parts. The rheostat put out by this firm is mechanically right and already has found a firm market.

The Premier Radio Manufacturing Co., in their new plant at the corner of Berks and North 6th, are again in full production, with greater facilities at their command.

Haverstick & Co., of South Fifth Street, have built up a nice business in magnet and antenna wire.

The Federal Institute of Wireless Telegraphy have placed on the market the "3YQ" transformer, designed and manufactured by experts in radio and electric construction. Mr. Hill, in charge of the institute, which is "across the river" in Camden, is sure of the future of this product on the basis of its quality and workmanship.

The Yankee Radio Co., of Stiles Street, is producing variometers and vario-couplers of quality.

Sunday and Scholtz, of W. Cabot Street, expect to dazzle the fall market with the low list price of their variometer. They are speeding up production to be stocked for the fall rush.

The Miller Lock Company, of Frankford, and the American Cuckoo Clock Company, of Germantown, are two well-known firms who have recently entered the radio field.

The Foote Mineral Co., at 19th and Arch, are producing a high grade mineral product for use in Crystals.

Woolworth and Kresge are advertising "Radio Supplies" along with their regular "5-10-15-25" lines.

MORSCAN'S CATALOG

The Morscan Radio Company of Newark, N. J., will have their 208-page catalog ready for shipment next month, and judging from the proof sheets this catalog is a complete one, showing wireless parts of every kind, and retailers can easily sell goods from this catalog. This catalog is to be had upon payment of 50 cents, which amount is rebated on initial orders.

DEPENDABLE



LINE

DIAMOND :: QUALITY

PRECISION RADIO INSTRUMENTS

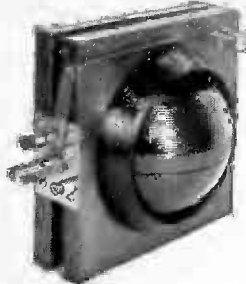

No. 41 - VARIOMETER

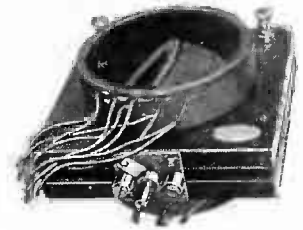

No. 42 - VARIOCOUPLER

TRANSFORMERS

CONDENSERS

CORRESPONDENCE SOLICITED

THE EASTERN SPECIALTY CO.

3551 N. FIFTH STREET

PHILADELPHIA, PA.

COMPLETE TUNING TUBE SET



**AT THE
PRICE
OF A
CRYSTAL
SET**



Specifications of THE MECO RECEIVING SET are:

- A 5" x 6" x 9" Mahogany finished Cabinet, with nickel plated handle.
- Hard Rubber Panel.
- Radion Dials and nickel-plated Binding Posts.
- Induction MECO Variometer Type.
- Condenser H M Type.
- Raditron U. V. 200 Tube.
- Turney or Frost Double Head Set.

- LIST PRICES:
- Complete (without batteries)..... \$35.00
 - Without Head Set..... 30.00
 - Extra Head Set..... 6.50
- One or two steps can be added at a small additional cost, prices upon application.
Dealers and Jobbers write for proposition to handle "Meco" Wireless Products.

MELCHIOR EQUIPMENT COMPANY

Manufacturers of Radio Products

306-8 East 34th Street,

New York, N. Y.

Watch the next issue of the RADIO DEALER for our MECO knock down set.

National Association

(Continued from page 21)

sidered best to have the national headquarters located at some OTHER place than the office of THE RADIO DEALER. It may be best to locate these offices in some other city. This will be a matter entirely up to the membership of the association. Until the membership of this organization is ready to maintain their own offices the services of THE RADIO DEALER organization is at their command, not only at the New York office, but at the branches at Chicago, Pittsburgh, Los Angeles, San Francisco, Boston, Newark and New Orleans.

Organization

The present plans for this association, which have been endorsed by every member so far, tend for the forming of three distinct branches of the association, one serving each of the three divisions of the trade.

There is a definite need for a retailers' organization, a definite need for a jobbers' section, and a need for a national manufacturers' association. A greater portion of the expense of promoting a national association falls on the first members, and it has been decided that for the purposes of economy one association shall be formed, which later will be divided into the three classes outlined. As the membership and financial strength of the organization increases three separate and distinct associations may be formed. Until this is done arrangements will be made for group meetings and discussions at all conventions, etc.

By the Trade

The formative stages of many associations show a heavy expense for organization due to the necessity for

employing high priced 'organizers' to gather memberships. It is expected that this expense will not be incurred by the association, but rather that readers in the trade in every section will accept posts as sectional organizers and push the work through their own connections.

Organized by the trade itself, without the interference of outsiders, the Radio Trade Association should grow much more rapidly than were there to be the suspicion of a personal financial gain in store for those soliciting memberships.

It has been suggested that in certain of the larger radio centers it may be desired that local bodies be formed to consider local problems. In these cases the local organization membership will elect all officers and direct the operation of their own group. THE RADIO DEALER is ready to assist in any such organization and already has made steps to prepare for two such city groups. There are many local problems that can easily be handled by the local trade, working together for the common good, and it is considered better for the national association to devote its greatest efforts to national questions, at all times, however, standing behind any local movement for the better interests of our industry.

Officers outlined for the association will include the following: National president, national secretary and national treasurer.

They shall be governed by the national board of directors, of which board the president shall be the head. Considerable discussion has been aroused over the size of this board but the consensus of opinion seems to point towards a board of fifteen members. To insure a national viewpoint on this board it is suggested that two members be elected from the far west,

from the south, from the central states, from the section northeast of New York, including that city, and two from the section south of New York City, which would include Newark and the other Jersey centers of the industry. This would leave five members to be elected from the country at large. This point is included in the questions to be voted upon by the membership in a mail ballot during the month of August.

It also has been suggested that this board membership be apportioned equally among the three classes of memberships. That is five manufacturers, five jobbers and five retailers. This question also will be voted upon.

Nominations are in order for membership on this board, which will be elected by a vote of the association. Nominations will be invited when the first ballot by mail is taken on the points above outlined.

Vice-presidents heading committees will be prominent in the work of the association. Suggestions received to date for these committees include the following: Supervision of shows and expositions.

Co-operation with amateur bodies working for the betterment of the industry.

Supervising the association laboratory and regulating standards for equipment.

Publicity, which might later include a national publicity service for all newspapers.

National exposition for the membership only.

Legal committee.

Membership.

No schedule of dues has yet been proposed. It seems the general opinion that these should be as light as possible until the association is ready to take on the expense of a paid secre-

Ideal Plant is Home of High Grade Apparatus



Located on one of Chicago's finest boulevards and adjoining a beautiful park, yet within a few moments' ride from the heart of Chicago's great business center, is the sunlit and lake breeze cooled modern radio manufacturing plant of the General Radio Equipment Mfg. Co. Location, working conditions and manufacturing equipment are ideal here, all of which are reflected in the workmanship and efficiency of the product. Inside and out, the building is beautiful and clean. It is a pure comfort to work here and a great satisfaction to the owners to see the appreciation of the workers, shown by the production of the high grade radio apparatus with which this company is identified.

tary with suitable headquarters and staff. This point will also be discussed in the coming mail vote.

Charter memberships can still be sent in, the application blank appearing on page 21 of this issue.

LETONITE PARTS

The Scheuroth Letonite Company, of 2378 Third Avenue, New York, are the originators of Letonite, used largely in the manufacture of Radio dials, knobs, switches, and other apparatus for radio sets

The company's factory is well equipped to handle large contracts, as they have seven presses ready for work on the moulding Radio parts. The die work is in the hands of experts under the supervision of J. Heitenger, who has long been identified with composition work.

The complete line of Radio parts fashioned by the company includes dials, knobs for switch contacts, rheostats, terminal binding posts, with six and 8/32 threaded inserts, variometers, sockets and condenser plates.

Letonite itself is an electric non-conducting and incombustible composition. The company is prepared to give efficient service with deliveries within one week to ten days on such parts for which the moulds are ready.

SHIP-SHAPE VARIOMETER

The Scientific Dealers Supply Co., of Chicago, for the past six months have manufactured variometers and couplers which are not only ship-shape, but manufactured scientifically and technically by experts, and have given the trade satisfaction throughout.

The variometer has an ebonized finish, which is highly dielectric and wound with D.C.C. green copper magnet wire. All metal parts are nicked, and the rotors have pig-tail connections. This makes a good looking and saleable item.

The vario-coupler tube is made of formica, and the rotor of mahogany with an ebonized finish, and also is wound with D.C.C. green copper magnet wire. All metal parts are nicked and the rotor has pig-tail connections.

"HE WHO LAUGHS LAST"

Some of the Bronx retailers are getting even with a certain Bronx jobber who was charging a bonus "when things were kind of hard to get." This gent is now looking for business, and offering BIG discounts.

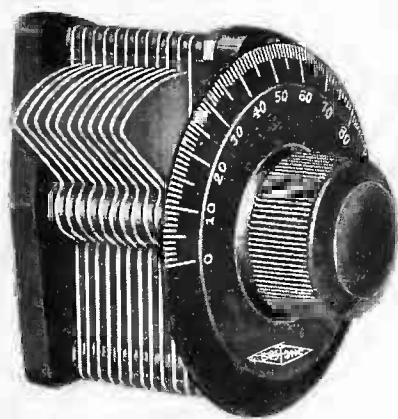

Investigate



the radio line which is scientifically correct—and which will afford greatest profits for the dealer

"BESTONE" PRODUCTS INCLUDE:

- | | |
|-----------------------------------------------------------------------------------------------------------------------------------------------------------------------------------------------------------------------------------------------------------------------------------------------------------------------------------------------------------------------------------------------------------------------------------------------------------------------------------------------------------------------------------------------------------------------------------------------------------------------------------|------------------------------------------------------------------------------------------------------------------------------------------------------------------------------------------------------------------------------------------------------------------------------------------------------------------------------------------------------------------------------------------------------------------------------------------------------------------------------------------------------------------------------------------|
| <ul style="list-style-type: none"> Variometers Vario-Couplers—150 to 600 Meter Vario-Couplers—150 to 580 Meter Amplifying Transformers (Mounted) Horizontal Crystal Detectors (Glass enclosed) Vertical Crystal Detectors (Glass enclosed) 3-in. Dials 2½-in. Dials 3000 Ohm Headsets (Navy Type) 2200 Ohm Headsets Inductance Switches 23 Plate Variable Condensers (.0005 MFD) 43 Plate Variable Condensers (.001 MFD) V. T. Sockets Telephone Plugs Closed Circuit Jacks | <ul style="list-style-type: none"> Open Circuit Jacks Two Circuit Jacks Filament Rheostats Mounted Galenas Crystal Cups Midget Insulators Ball Insulators Metal Binding Posts Composition Binding Posts Large Metal Binding Posts Large Composition Binding Posts Switch Points Switch Stops Switch Levers Phone Condensers Grid Condensers Filament Rheostats with Dials |
|-----------------------------------------------------------------------------------------------------------------------------------------------------------------------------------------------------------------------------------------------------------------------------------------------------------------------------------------------------------------------------------------------------------------------------------------------------------------------------------------------------------------------------------------------------------------------------------------------------------------------------------|------------------------------------------------------------------------------------------------------------------------------------------------------------------------------------------------------------------------------------------------------------------------------------------------------------------------------------------------------------------------------------------------------------------------------------------------------------------------------------------------------------------------------------------|

Write for New Catalog

HENRY HYMAN & CO., Inc.

Manufacturers

NEW YORK
476 Broadway

CHICAGO
212 W. Austin Ave.

SAN FRANCISCO
711 Mission St.

The MULTILISTENER

8 Phones in 1—Patents Pending

Radio Multiple Listening Outfit

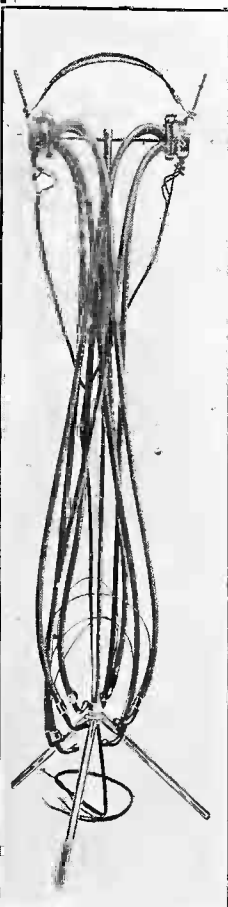

Complete with Stand

List \$10.00

For Crystal or Tube Set



Comfort for the WHOLE FAMILY

Mounted on Nickel Plated Polished Brass Stand
Adjustable to a Height of 46 Inches

Manufactured by

F. C. MANNING COMPANY
57 Spring Street, :: Newark, N. J.

Variable Condensers

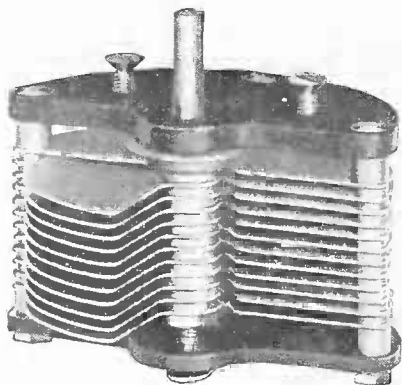

Variable condensers to be efficient must be well made. Loose joints or faulty construction soon allows the plates to get out of alignment and decrease their efficiency.

A seasoned organization backed by a half million dollar equipment have placed the United Condensers in the front rank with radio engineers the country over.

Prices—43 plate, \$4.50
23 " 4.30
11 " 4.00
without dial or knob.

Liberal discounts to jobbers and dealers.

We invite correspondence with Radio Manufacturers who are interested in using our facilities and services for manufacturing Radio Equipment.

United Mfg. and Distributing Co.

536 Lake Shore Drive Chicago, Ill.

Fall Chicago Show

Coliseum Designed to Give Plenty of Room for Visitors

Chicago Radio Show, to be held at the Coliseum, Oct. 14th to 21st, promises to be of great interest to the manufacturers throughout the country. The management recently sent questionnaire-letters out to hundreds of manufacturers in the radio field, seeking expert opinion and comment on the point of the demonstration of the loud speakers and amplifiers, and were more than gratified by the immediate response to this letter. Upwards of 80% of the firms so addressed replied, giving some very valuable suggestions as to regulations of this point, and a great number signified their intention of becoming exhibitors at the show.

Although the management has not yet issued their prospectus, the writer was favored with a glimpse of the floor-plan just before it was sent to the printers. One very noticeable feature of the arrangement is the enormous space devoted to aisles. The plan shows that 40% of the floor-space of the Coliseum is devoted to exhibit booths and 60% devoted to aisle space. This will assure comfort, not only for the public, but for the exhibitor whose experience is usually that he is crowded to a point where he is unable to take the proper care of visitors. There is a main aisle or colonnade running from the west main entrance to the east wall, which is 30 feet wide and the aisles running North and South in the building are 17 feet wide.

The architectural scheme of the booths is particularly striking, as each booth is backed with a handsome stained art glass effect. The color scheme of the booths is cream and gold, finished off with natural potted ferns.

Another striking feature of this exposition is its arrangement for a business service department, which will be located in the Coliseum Annex and will enable the exhibitor to conduct his business with the same efficiency as though he were in his own office. In this gallery will be found a Sub-Post-office, with Registration and Money-Order Service, an Express Office, rooms for private conferences, public stenographers, Western Union and Postal Telegraph Service Depots and a Press reception room and rendezvous, where representatives of the trade publications and daily newspapers can meet the exhibitors and visiting representatives of the trade.

Although not a single contract has been made for space as yet, enough advance applications have been received to warrant the prediction that the space will be oversold following the issuance of the prospectus, and all these applications have been received from bona-fide manufacturers of radio apparatus or contributory products. With an exposition building such as the Coliseum, it is expected that Chicago will carry off the honors as having presented the greatest manufacturers' exposition and this will mean the first step towards the organization of the radio industry and placing it on a footing that will assure its progress and development.

JOHNSON MOVES AGAIN

For the second time this year, Paul F. Johnson, the enterprising Radio dealer of Pasadena, California, has been forced to move into larger quarters. This time 562 East Colorado Street, Pasadena, houses his Radio store, which Mr. Johnson says, is the largest strictly radio shop with the largest stock anywhere west of Chicago.

Coincident with moving into his new shop, Mr. Johnson took the opportunity of enlarging his stock.

TURNEY HEADSETS

List Price \$6.50

Trade Discount 40%



3000 ohm.

Weight 8 oz.

Your Customers Will Want
Turney Headsets

Get Ready for the Fall Demand
Retail Price \$6.50—Your Price
40% off, \$3.90.

Send your order now.

REX RADIO SALES CO.
1452 B'way New York, N. Y.

Racony Plug

Company's Executive Intent on Development of Product

The Radio Company of New York, manufacturers of the Racony line of radio apparatus, have just received their corporation papers, and they will hereafter conduct their business under the caption Racony Corporation.

This organization is composed of a quartet of young men who have been thoroughly trained in the manufacture and marketing of radio and kindred apparatus and their motto since their inception has been "Quality First."

The chief engineer of the corporation, Mr. Felix Lewin, received his technical training in a university and he has been actively engaged in the design and manufacture of radio apparatus for the past ten years. Mr. Lewin was appointed 1st Lieutenant in the World War and he saw several years service in the A. E. F. during which period he secured some valuable experience in training.

Julius Schoenberg is Director of Sales for the company. His experience dates over a number of years and he has to his credit the most successful marketing of a number of lines. Mr. Schoenberg gives his personal attention to the sales affairs of the company and is at all times actively in touch with its clients.

A. L. Hecht who is in charge of the purchasing is eminently fitted to conduct his duties to the greatest possible advantage. All raw materials which enter the plant are given the most extensive and exacting tests by a member of the engineering force especially appointed for that purpose.

Last but not least: Mr. Nathan is in charge of the executive matters of the corporation and he controls with the most excellent effect the force of which he is in charge.

The company manufactures a complete line of receiving apparatus specializing in the manufacture of the Racony Plug which, because of its adjustability has been a great success. This plug is composed of the finest grade of material obtainable and it is trouble proof in operation. The finest grade of mica-dielectric obtainable is used in its construction and the constants of the instrument have been carefully computed in such a manner as to make it highly efficient under the most difficult conditions and it stands voltage strains many times in excess of any which it will be called upon to withstand in actual practice. The company also has in process of evolution a receiving instrument housed in a period type cabinet. This new instrument embodies a number



The S-P-2 RECEIVER

A Remarkable Refinement in Radio

The S-P-2 Receiver is offered, at a list price of \$85, as the most remarkable VALUE and QUALITY achievement in the history of radio.

This Receiver has been developed by our own experts with a view to furnishing a complete Receiver of radio-telephone and radio-telegraph signals over a wave length range of from 180 to 650 meters, using three tubes, viz.: detector, one stage of radio frequency amplification and one stage of audio frequency amplification.

WITH THIS ASTONISHING RESULT, that the volume of signal received is EQUIVALENT TO THAT OF ANY REGENERATIVE CIRCUIT RECEIVER, DETECTOR AND TWO-STAGE AUDIO FREQUENCY AMPLIFIER ON THE MARKET TODAY, the S-P-2 in price comparison offering *one to two times* GREATER VALUE.

In emphasizing REMARKABLE REFINEMENT, we claim for the S-P-2 a TONE QUALITY of distinct class. The great "evil" of radio (harsh and distressing foreign noises) has been wonderfully overcome in the amazing manner in which the S-P-2 PRACTICALLY ELIMINATES all atmospheric disturbances, commonly known as static, and also such interferences as received from local power stations, arcing commutators, street cars, rumbling traffic, etc.

The S-P-2 accomplishes the exit of the day of blatant and aggravating "noise" in radio reception. It brings the QUALITY in music and in all instrumental and vocal signal that is now universally desired and demanded.

The S-P-2 Receiver is also especially designed for the reception of long distance and weak signals. In thorough tests, using a single wire antenna

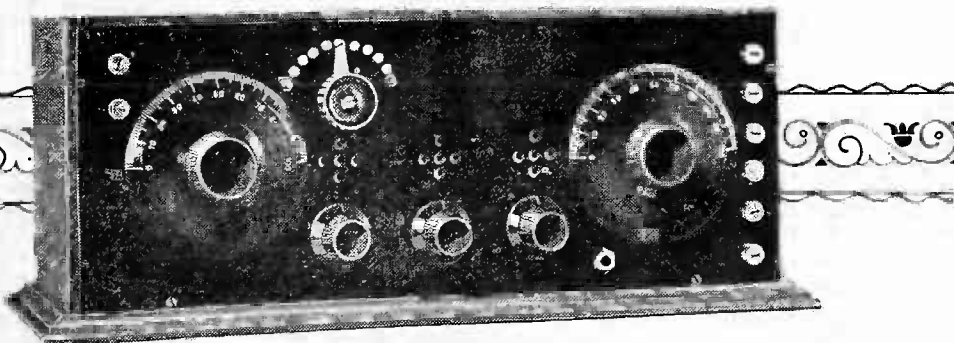

40 feet long and approximately 20 feet above ground, the entire broadcasting programs of Newark, N. J., Schenectady, N. Y., Atlanta, Ga., Detroit, Mich., and Kansas City, were received nightly in Pittsburgh, Pa.—and during the mid-summer, supposedly poor receiving months. This reception was duplicated when using four wires strung along the ceiling of a one-story building. In the most severe tests, interference from static was not noticeable.

It is the unreserved opinion of every expert who has observed the S-P-2 that this receiver is the marvelous advancement for which the radio world has been intently seeking.

Dealers, write today for Catalog 101B

PITTSBURGH RADIO SUPPLY HOUSE

Bell Telephone Grant 3632

963 LIBERTY AVENUE, PITTSBURGH, PA.

Buy Apparatus
From a Reliable Manufacturer
FREED-EISEMANN RADIO CORP.
255 Madison Ave., New York City

KRAMER RADIO COMPANY
4713 Sheridan Road. CHICAGO. ILL.
MIDWEST DISTRIBUTORS
Of Quality Radio Products
Write Us for Catalog and Discounts

MANUFACTURERS OF
Receiving Sets Complete
Unites Mounted and Unmounted
Send for Description and Prices
RADIO OUTFITTING CORP.
Mfg. High Grade Radio Apparatus
410-412 East 34th St. New York, N. Y.

MANUFACTURERS & JOBBERS
why pay for a mailing list of dealers when our advertisers get it FREE
The RADIO RED BOOK
NAT'L EDITION
call watkins 5987 for information

JUST OUT

Radio Trade Directory
AND
Buyers' Guide

120 Pages

Of interest to every man in the Radio Business

THE RADIO RED BOOK

Price \$1.00

Circulation 25,000

Write for Rates

Sold Direct From

Radio Red Book Pub. Co.

406 W. 31st St.

New York, N. Y. Watkins 5987-88

of radical and novel features, but following its invariable custom the company for the past six months has been subjecting their new product to the most rigid tests before offering it to the trade.

The company maintains its executive and sales offices at 799 Broadway, New York City, and its plants are located at Brooklyn, New York, and New York City.

Every instrument is tested before leaving the company's plant and the plug is delivered to the user with the absolute assurance that it will perform the work for which it was built without trouble to him.

The Racony Plug is the product of a great many years of experience on the part of its designer, Mr. Lewin, and the Racony Corporation controls basic patent applications covering its adjustable features. Because of the great variation in lighting circuits it is absolutely essential that an antenna plug be closely adjustable to the conditions under which it is to do its work. This feature of the Racony Plug is original with its manufacturers.

SMALL SET APPEALS

One of the smallest vacuum tube sets on the market is the "Merco," put out by the Melchior Equipment Co., 306-8 East 34th Street, New York. Its dimensions are 5" x 6 x 9.

Needless to say, it is a portable set, but the "Merco" is a specially de-



signed portable outfit. The cabinet, of mahogany finish, has a nickel-plated lock and handle which enables one to carry the set with ease and safety. All the wiring with the tuning tube is enclosed. The dials and nickel-plated binding posts are on the exposed side of a hard rubber panel. The outfit retails complete with a Turney Double Head Set for \$35.

POPULAR NEW YORK SHOP

One of the best equipped radio shops in the Bronx is run by Charlie Mandelbaum under the name of the Fordham Radio and Specialty Co. at 2486 Webster Ave. Charlie reports good business. This store handles only high class equipment and it seems that the Bronx folk know good things when they see them.

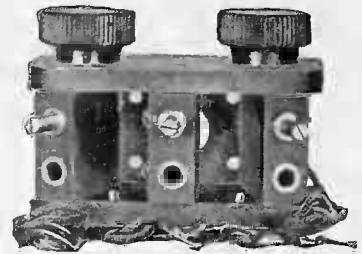

COIL MOUNTINGS

Entirely Machined
Precision Products
Material of "Radion"

Triple Mounting *\$4.50 List
Double " *\$3.50 "
Single " \$0.45 "

*Price Complete With Flexible Leads.

QUALITY GUARANTEED
IMMEDIATE SHIPMENT

Most Liberal Discount to
Jobbers and Dealers

YORK RADIO CO.

1384 Bristow St., New York City

**VARIOMETERS
VARIO-COUPERS**

DOUBLE - GREEN
SILK WINDINGS

Highly-Polished Black
Moulded Insulation

HIGH INDUCTANCE
LOW CAPACITY

Designed to Cover the Amateur
Wave Lengths Efficiently, for
Very Close Tuning

IMMEDIATE SHIPMENT

MAGNETIC MFG. CO.

269 23rd Avenue

MILWAUKEE, WIS.

RADIO FREQUENCY UNITS

Radio frequency amplifiers for use on non-regenerative sets are one of the specialties put out by the American Radio and Research Corporation, Medford Hillside, Massachusetts, under the trade name of "Amrad."

The Amrad line includes two types of radio frequency amplifiers, No. 3071, for use particularly with a short wave tuner and two stage amplifier; and No. 3045 for use with radio units. The two styles are designed, however, especially for use in conjunction with Amrad units.

It is the established Amrad policy never to bring out new and improved equipment that would render obsolete previous Amrad products. The makers by this policy would assure the buying public that their equipment will not become inferior due to progress in the art.

Both radio frequency amplifiers are identical, except that No. 3071 is encased in a cabinet with rounded corners while No. 3045 is provided with square corners. Conforming in design with the needs of radio frequency amplifiers, so that they can be used for various wave length bands, the Amrad instruments are ideal from this point of view, the makers claim.

FALLGATTER'S NEWEST

The Embe Model OG Variocoupler is one of the specialties of Marvin B. Fallgatter of Waupaca, Wisconsin. This is a well-designed instrument of pleasing appearance. Windings are of green silk-covered wire, primary wound on Formica tube. The shaft is 3-16 of an inch in diameter to fit the standard three inch dial. Coupling is variable 90° either side of minimum, thus affording a more complete adjustment than is ordinary possible in 180° instruments. The maker says that every need for efficient reception is filled by the Embe variocoupler. The price is \$4.50, list; complete with 3 inch dial and knob, \$5.00 list.

NEW STATION IN RUSSIA

Recent advices received at the Department of Commerce from Trade Commissioner Young, Riga, state that during May a new wireless telephone broadcasting station, located on the Kursk Railway station in Moscow, was opened by the People's Commissariat of Post and Telegraphs. The station was built by the Nizhni-Novgorod laboratory of the Government, and is designed to broadcast messages and press news sent out by the Government.

The Conquering Power of Superiority

Formerly custom built for particular Radio Fans. Now available for distribution through jobbers and distributors who want the best for customers who DEMAND the best.



THE CONQUEROR

Radio buyers quickly grow to be discerning and critical buyers. Thousands of them are seekers of the best.

Insure for yourself the selling advantages and sales profits of The Conqueror's Superiority. Write for particulars.

The Conqueror is adjusted and controlled by ONE KNOB. RESULT: Quick, easy, simple and super-sharp tuning.

FOURTEEN EQUALLY BIG FEATURES

- 1—Size of instrument 7½ x 15 inches. Entire equipment, tuner, detector and two stages of amplification in one handsomely finished solid mahogany hand-rubbed cabinet.
- 2—Wave Length: From 150 to 15,000 meters.
- 3—Panel and Shelf: XX BAKELITE, shielded. Bakelite binding post strip.
- 4—Rheostats: Special design, Ideal metal, air cooled. No dissimilar metals in contact to cause corrosion.
- 5—Potentiometer: fine, control of detector plate voltage.
- 6—Sockets: made with locked contact. Positive contact, permanently efficient.
- 7—Transformers: designed for maximum amplification
- 8—Wire: square tinned copper, bus-bar type.
- 9—Condenser: no dielectric or bearing losses; balanced commercial type, single bearing, vernier attachment.
- 10—Only one duty performed by each battery—no greater drain on one than another. Even life—longer life.
- 11—No dead ends to reduce signal strength by absorption.
- 12—Absolute positive control of various tube circuits.
- 13—All Nickeled Parts highly buffed.
- 14—Certification; all parts and the complete instrument certified by laboratory test.

Lewis & DeRoy Radio Corporation

Manufacturers
of CONQUEROR PRODUCTS

560 Seventh Avenue
NEW YORK CITY

TELEPHONE BRYANT 7759

ROUND-CELL BATTERY

The Magno Storage Battery Corporation of New York have but recently placed on the market a new type of storage battery, which can be charged in one minute by anyone, anywhere. The battery is particularly well adapted as a radio "A" battery equipment, for all forms of ignition, small lights, door bells and elevator buzzer systems.

The outstanding feature of the battery, a 2-volt unit, is its interchangeable charged positive electrode. The battery is so constructed that it can



be shipped "bone dry" in a fully charged condition. It will thus hold its full charge indefinitely without the slightest loss of its potential power. Upon the introduction of the sulphuric acid electrolyte, its full strength becomes instantly available.

Unlike other batteries, the charge is contained only in the positive electrode which can be removed when discharged and a "spare" fully charged electrode inserted in its place. The use of this battery in radio work insures the user against interruption of receiving; and in other cases against the annoyances and delays due to a



Showing attractive front of Montclair Radio Mfg. Corp., of Montclair, N. J.

ROSEMARK RADIO RECEIVING SETS



Rosemark Two-Stage Unit
(Pat. Applied for)

Three Styles: Detector, One Stage, and Two Stage

THE SIMPLEST TUNER MADE: The Rosemark Selective Coupler (Pat. Pending), a revolutionary step in coupling devices, gives this instrument a simplicity of operation that astounds expert and amateur alike. Does away with expensive vario-coupler and variometer, thereby reducing bulk and expense. Simplicity commensurate only with results.

Every Instrument Tested and *Guaranteed* Against Electrical or Mechanical Defects

DISTRIBUTORS BEING ASSIGNED.
DEALER CORRESPONDENCE SOLICITED.

ROSEMARK RADIO CORPORATION

Southern Distributor
Wm. W. Moyle & Son
Charlotte, N. C.

Manufacturers of Radio Apparatus
29 Lexington Avenue
New York City

Mid-West Distributor
Hi-Gee Radio Mfg. Co.
Marion, Ill.

discharged battery which must be taken to a service station, the makers assert. The electrodes can be renewed at a nominal figure.

A number of exclusive basic features are contained in this battery, such as the entire elimination of separators as well as the usual grid construction, the use of an all-metal alloy negative plate, and the property in its active material which makes it possible to expose the plates to the air or light without the slightest detrimental effect.

Various important advantages are derived through these features, it is claimed. In the first place, the elimination of separators reduces the amount of internal resistance. The construction of the positive plate inclosing the active material eliminates buckling. A short circuit even to the point of completely exhausting the charge will not injure the battery, nor will any ill effects follow neglect of the electrolyte, it is claimed. The battery under such maltreatment will show a remarkable recuperative power. It is further maintained that this operation can be repeated several times before the voltage finally drops to a point where it is necessary to insert a new fully charged electrode. Due to this feature, the battery has a greater actual capacity than its rating.

MULTILISTENER OUTFIT

The Multilistener, made by F. C. Manning Company, 57 Spring Street, Newark, N. J., is an instrument by means of which any number of persons up to eight can listen in from one double head set.

The apparatus transmits the sound waves direct to the ear without distortion and with clearness. Two drums cover the diaphragms of the head phones. To each drum four tubes of high grade wall rubber are attached, enabling the listener to get the full benefit of each phone whether used singly or in pairs. The instrument can be used with either crystal or tube sets. Patents for the device are pending. A stand goes with the outfit, which provides for convenient handling and arrangement of the Multilistener.

The Multilistener retails for \$10.00, or \$7.00 without the stand.

MAKERS ORGANIZE

Radio apparatus manufacturers met at Washington on July 26 and effected a temporary organization of the National Radio Chamber of Commerce. W. H. Davis was elected President and Harold Powers, of "Amrad" was made Vice-President.

GENERAL ELECTRIC FORMS MERCHANDISING SYSTEM

The General Electric Company recently announced the formation of a new merchandising department which will have charge of products that are now handled through resale channels. This organization will consist of three divisions, the administrative, supply sales and motor sales. George P. Baldwin will be general merchandising manager and H. C. Houck assistant general sales manager. The new organization will begin to function about August 1.

The administrative department will be divided into sales promotion, research, advertising, publication and supply house section. The supply sales division will be in charge of a sales manager and an assistant with section managers covering fans, wiring devices, conduit products, rectifiers, wire, transformer products and miscellaneous supply products. The motor sales division will cover the small motor field.

LIGHT HEAD SETS

Weighing only nine ounces complete, "WesKen" featherweight head-set manufactured by the Stevenson Brothers Sales & Engineering Co., Pittsburgh, Pa., is especially designed for the comfort of the user.

The resistance of the set is three thousand ohms, the standard for ordinary use, and indeed the whole outfit is made with the end of artistic appearance and comfort for the ordinary user as the goal. The light weight effect is achieved through the use of cord head bands, and freedom from protuberances that will catch in the hair. The cords are of high grade material with mercerized covering, and the phone cases are of moulded bakelite or condensite. These are optional.

Stevenson Brothers Sales & Engineering Company, whose full address is Richland and Finance Streets, Homewood P. O., Box No. 5, Pittsburgh, Pa., also make their WesKen Loud Speaker receivers. While obtaining with these phones the refinement of the lower frequency, it is claimed that the WesKen phones are not supersensitive on the high notes and the high frequency.

OPENS NEW STATION

The Radio Electric Company of Pittsburgh has recently been assigned call letters WHAF for their broadcasting station. Scheduled programs will begin about September 1.

This broadcasting station will be under the direction of Parker M. Wiggin, Chief Engineer of the Radio Electric Company.

SPECIALTY SERVICE COMPANY

Manufacturers of
RITE RADIO PRODUCTS
Distributors for
LAWSAM RADIO PRODUCTS
and Other Standard Equipment

Write for Prices and Discounts
Cor. 4th Ave. and Pacific St.

Brooklyn, N. Y.

Marconi says:

THIS country is far in advance of any other in the radio development—so does NYCO; we ought to know, because we are supplying dealers and amateurs throughout the country with the best standard equipment.

A complete set—or any part of it!

"Write for our latest price booklet"

Radio



Supplies

507 PENWOOD AVENUE

WILKINSBURG, PA.

MODERN

RADIO
EQUIPMENT
COMPANY
TRADE MARK

ESTABLISHED 1911

The Original and Genuine Mica Diaphragm Amplifying
Loud Speaker

LIST PRICE \$28.00

50% Off to Dealers

CHEAPER THAN THE WORTHLESS IMITATIONS

SPECIFICATIONS

HORN: Seamless brass, triple lacquer, scientifically correct. Gives a rich, clear tone, not a metallic rasp.

AMPLIFYING CHAMBER: Exclusive "Modern" amplifying chamber of machined aluminum, polished and lacquered.

RECEIVER: Highest grade mica diaphragm amplifying receiver, built like a phonograph reproducer.

BASE: Oak wood base finished in early English, green felt bottom.

POST: Eby patented binding post.

NO BATTERIES ARE NEEDED TO OPERATE THIS LOUD SPEAKER—JUST CONNECT IT TO YOUR SET—PRESTO—HEAR 'EM ALL OVER THE HOUSE.

This is the original and genuine loud speaker—designed to do the work of a loud speaker—and is not an empty horn or shell that "any" receiver fits.

The Makers of the "FIRST" are Makers of the "BEST"

HORNING EXPERIMENTAL LABORATORIES

Sole Distributors of "Modern Apparatus"

Elizabeth Trust Company Bldg.

ELIZABETH, N. J.

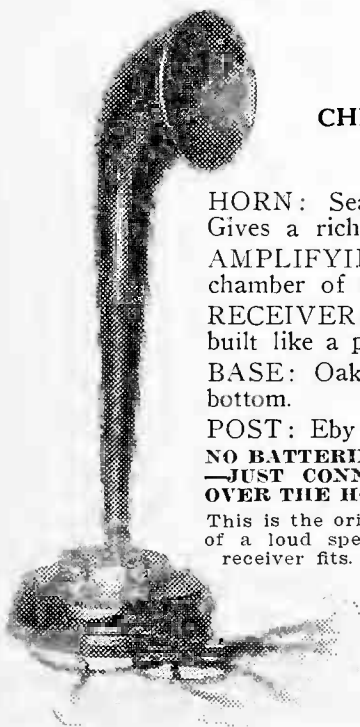

Radiolite, a New Phase in Radio

Beauty is the Aid of Science in New York Company's Remarkable Product, Due to Startle Industry

By THOMAS J. RYAN

To combine the beauty of bygone days with the utility of the present era is the aim of all modern craftsmen and the advent of Radio has given artisans in this country the opportunity to express the miracle of art in the new miracle—Radio.

Quick to seize upon the ideas which Radio has inspired is the Radio Equipment Service, a group of New York craftsmen whose shop is within sight and sound of the most artistic street in America, Fifth Avenue. The inspiration of their surroundings is expressed in what they are pleased to call their life work—the Radiolite.

With an originality that is akin to genius, the Radiolite wireless units have many distinctive features, all with the one idea of beautifying the home where the ordinary Radio cabinet has its hundred wooden panels, the Radiolite is unique in its panels of pure sheet mica, upon which are fairy-like designs in wrought iron.

It requires an actual view of the Radiolite to catch the beauty of the Radiolite when in operation. While the sounds of piano or human voice issue from the Radiolite, a light in the interior is turned on and through the tinted mica with its iron tracery issues a soft diffused glow permeating the room.

It is unfair perhaps to the Radiolite to speak of wrought iron as one of its constituents. Wrought iron suggests, something uncouth. The Radiolite is anything but that. all the tracery and filigree in it is of the most delicate and fascinating design, colored in bewitching tints to harmonize with the glow of the transparent mica.

The accompanying sketch of the Radiolite suggests but faintly the quiet dignity and beauty of this new advance in settings for Science's latest art. As may be seen there are three divisions, one concealing the battery, the centre the loud speaker and the third the radio apparatus itself. The sections are designed to accept the standard units, so that the owner may install

additional steps of audio frequency or radio frequency units after the initial purchase with only the detector and two-stage unit enclosed.

The loud speaker is ready for use, for the panel in front is of finely screened copper in harmony with the rest of the cabinet and through this the sound travels. To adjust the batteries or the Radio units, doors specially patented are in the rear, out of sight.

The sketch here reproduced is of the Italian Renaissance *motif*. Other period designs, such as Chippendale, Louis XV, and Jacobean, are represented in Radiolite cabinets.

It may be asked on looking at this beautiful piece of furniture, which resembles anything but the usual Radio outfit with its confusing array of

But in that shop at 500 Fifth Avenue there is also on display a host of artistic pieces of furniture adapted for use as Radio containers. There one sees tall floor lamps with iridescent mica, chandeliers that act both as aerials and as loud speakers, and candelabra.

These pieces are made to order or are already in stock, for quantity shipments, but such is the variety of their design and so unique is the use to which they are put, that there is no suggestion of the "factory output" stamp upon them. On view at the showrooms of the Radio Equipment Service they impress one with the beauty of the wrought iron coloring and the appeal of the light shining through the mica.

Radiolite is also made in a commercial unit adaptable to indoor and outdoor electric sign advertising. While a program is being presented by the Radio set, the wares of advertisers are flashed upon the mica panels. This is a striking form of advertising and is suitable to any form of business publicity.

This commercial form of the Radiolite, is, however, based upon the home Radiolite. It is this that is the great achievement for which the Radio Equipment Service of 500 Fifth Avenue, New York, is to be congratulated.

RECOLA LOUD SPEAKER

A loud speaker with a base of cast aluminum and a horn of spun brass is made by the Radio Electric Company of Toledo, Ohio, under the trade name of "Recola."

The "Recola" loud speaker is similar in appearance to a phonograph horn, and it permits the use of any standard receiver. It stands 14 inches high, the bell of the horn being 10½ inches. The bell is nicked.

"Recola" loud speakers have a shipping weight of six pounds. They are packed in separate containers suitable for reshipment.

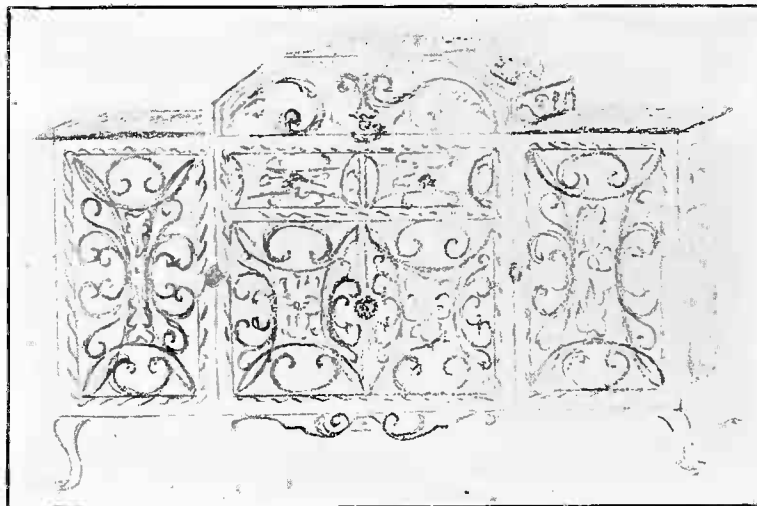

RADIOLITE IN ITALIAN RENAISSANCE
One of the period designs of this radio cabinet.

wires, dials, aerials and knobs, "Where is the aerial?" The makers of Radiolite have grasped the idea that if the Radio outfit is to become a fixture in the home it must be simple yet attractive in appearance.

The aerial is stretched around the square in the rear of the set so that it is in the form of a loop aerial but one that is conspicuous by its apparent absence. And it is this detail, among the others, that illustrates the careful planning of the designers to make their set suitable for the home. The Radiolite is ornamental and useful, compact and complete, self-contained and ever-ready to transform the room in which it stands into a quiet shrine of beauty.

RADIO ON INSTALLMENT

Radio instruments on the installment plan are offered by a New York firm. M. Taub, of the Atlantic & Pacific Radio Co., 131 West 37th St., is the originator of this new idea in Radio distribution.

Each instrument sold by this firm under its deferred payment policy is guaranteed for two years. Once a month the company sends out an inspector to see that the instruments in the hands of its clients are kept in good working condition. This also provides an opportunity for keeping the Radio user in touch with all the newest tricks and improvements in the science.

The purchaser of sets from the Atlantic & Pacific Radio Company is allowed one year to pay for the set in full. An initial payment of twenty per cent of the purchase price is required.

NELSON MAKES SET

Covering both amateur and commercial wave lengths, the Nelson Radiofone Receiver, offered by the Nelson Radio Parts Company, 89 Academy Street, Newark, is the result of careful study and engineering skill. It is not a regenerative set, because the manufacturers firmly believe that the regeneration of phone signals tends to distort them and necessitates extreme accuracy in tuning.

The Nelson Radiofone is, however, designed for easy adjustments by the amateur Radio fan, upon whom the commercial success of Radio depends. It is attractively constructed with a cabinet of dull mahogany finish, panels of grained bakelite, aluminum plate condenser, black moulded dials, Nelson standard coupler and variometer, and everything else of standard design, the whole being assembled into a receiving set of distinctive appearance and efficient performance.

GLOBE PLUG TESTED

The Globe antenna-attachment plug has been used successfully in Reading, Massachusetts, for receiving music and speech broadcasting in Boston approximately twelve miles away.

A single vacuum tube regenerative radio receiving set was connected to a radiator for a "ground" and to an electric lamp socket by means of the antenna-attachment plug. The electric light wires in the building served as an antenna. No 60 cycle "hum" was heard in the head telephones.

The antenna-attachment plug is 6½ inches long and 1¼ inches in diameter. Binding posts on one end of the device allow different values of capacity to be used.

JOBBER AND DEALERS!

THE SOUND WAVE CORPORATION still has some territory open for jobbers and dealers. We manufacture a quality line of

VARIOMETERS VARIOCOUPERS DIALS

and any other molded articles.

On September first we will have ready for delivery an inexpensive **LOUD SPEAKER** that has no equal at any price.

Inquire at once for prices, terms and territory

THE SOUND WAVE CORPORATION

30 GRAND AVENUE,

BROOKLYN, N. Y.



SUNSET Tuner and Detector

List Price \$11.00

200 MILE RECEIVING RADIUS

Dealers write for discounts

Jobbers write for discounts and territory

ARONAX RADIO SALES CO.

Sole Distributors For

SUN RADIO CO.

1114 S. Michigan Ave.

Chicago, Ill.

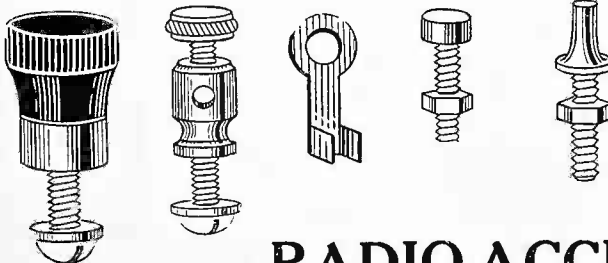

IMMEDIATE SHIPMENT

Also

All Other Radio Needs

WRITE FOR PRICE LIST

RADIO ACCESSORIES CO.

220 West 42nd Street

New York

ANNOUNCEMENT!

We now have the **LARGEST** and most complete stock of **RADIO APPARATUS** that we have ever carried.

We are prepared to make immediate shipment (except GREBE) on radio apparatus manufactured by the following:

MURDOCK, GREBE, CLAPP-EASTHAM, MAGNAVOX, WESTERN ELECTRIC, NATIONAL CARBON, A. C. ELECTRIC, CONTINENTAL FIBRE, ROEBLING, J. H. BUNNELL, FEDERAL TEL. & TEL., MU-RAD LABORATORIES, GENERAL INSULATE. WE are **DISTRIBUTORS** for the above and many others.

"THE BEST



IN RADIO"

VIRGINIA RADIO CORPORATION

Manufacturers—Jobbers

Charlottesville, - Virginia

The Chicago Show

(Continued from page 34)

pany, showing the Davistone clear speaker, attracted considerable attention from those in attendance. The booth was occupied by H. B. Davis, Miles S. Whitney, H. I. Orwig and H. E. McCrillus.

The Drisco Manufacturing Company line was exhibited by Harold M. Schwab, of New York, who is exclusive factory distributor for this line. Mr. Schwab was assisted by J. R. Wren.

The Ekko Company, showing their new model phonograph adapter, were ably represented by H. E. Freund and K. R. Hare.

The largest booth in the show was that of the Electric Service Products Company, showing a wide range of products sold by this company. The booth was in charge of P. C. Moore, assisted by David Cohen, Ralph Forbes and Max Boring.

The Electric Machine Company, of Indianapolis, displayed their general line, their exhibit being handled by B. E. Royse, W. J. Halliday and C. J. Schaf.

The Electric Research Laboratories, displaying Erla products, occupied

two booths, Marshall P. Fox, sales manager of the company, being in charge, assisted by E. J. Wiggins, Geo. A. Pearson, Hugh Robertson and Miss E. Dreeben.

Federal Telephone & Telegraph Co. were represented by Milo Gurney, displaying a number of Federal items

—featuring their amplifier for crystal sets.

The Ferry Radio Laboratory displayed their line of high-grade equipment.

The R. S. Fralick & Co. booth contained some of the products distributed by this company. In addition to



Showroom and Store of the Electric Service Supplies Co. of Chicago



Above is shown the attractive booth of the American Electric Company also of Chicago, who attracted quite a crowd by the use of flashing lights in the back of the booth.

The set shown on the right was one of the features of the Chicago Show, being a completely enclosed unit set, made by Radio Units Inc., of Chicago. This set operates without outside aerial or ground, every part being enclosed in the case the young lady has in her hand.



S. R. Fralick, president of the company, and B. J. Dillon, advertising manager, E. W. Denny, of the tising manager, E. W. Denny, of the Barkelew Electric Mfg. Co., and B. S. Berlin, of the Heinemann Electric Company, were in attendance.

The General Phonograph Company, of Elyria, Ohio, displayed their line of high-class equipment, the booth being occupied by Homer Stevens, general sales manager; R. G. Sidnell, radio engineer, and Dan F. Lane, sales representative.

The Hercules Radio Corp., of Chicago, jobbers and distributors, displayed a complete line, their booth being in charge of E. B. Miller, president, and Chas. Gordon, vice-president, and H. J. Birmingham, of the sales department.

The *Herald and Examiner* of Chicago, displayed the radio sets they are giving as premiums for subscription work done in the city. Their booth was occupied by F. D. Perne, F. Hurst and C. L. Nelson, of the radio department of the newspaper.

The Hipwell Manufacturing Company, of Pittsburgh, displayed Hipwell batteries, as well as their line of machined parts. The booth was in charge of Frank Weaver, factory representative.

The Hughes Radio Electric Company displayed their new model variocoupler, the booth being attended by R. E. Hughes and Frederick Wolcott.

The Jefferson Electric Mfg. Co., manufacturers of Jefferson audio frequency transformers, were represented by R. Benson, H. T. Moorman, T. C. Hawkins and A. R. Johnson.

J. E. Jenkins, Mid-West Radio Central, Inc., Chicago, Ill., occupied four booths, showing a general line, featuring the Jenkins rheostat. Personnel in the booths included: J. E. Jenkins, Thorne Donnelly, president of the Mid-West Radio Central; Chas. A. Sloane, W. D. Pearce, F. E. Gould, H. H. Stults.

Jewett Manufacturing Company, showing their line of parts, featuring A-B-C units. Elaborate booth, handled by R. C. Goheen and L. C. Goodell.

Lyon and Healy, elaborate large booths showing the large line distributed by this company. Their booths were in charge of Chas. P. Hindringer, manager of the radio department; Victor A. Nissen, Jr., E. W. Peterson, R. S. Ridgway, Miss Louise Whittiger and Fred Westaway.

M. & M. Co. of Chicago showed a very attractive line of sets, their booth

THE SENSATION OF THE SHOWS

Enco B Batteries



**Do Away
with
Waste**

Refillable with
standard flashlight
unit cells.

A single unit cell
may save the cost of
a new battery.

Dealers write for
proposition in your
territory

ENCO ELECTRIC NOVELTY CO., Inc.
Manufacturers of Standard and Refillable Batteries
603 West 130th Street
New York, N. Y.

being occupied by E. Minge and R. C. McMillen.

Maring Wire Co., of Muskegon, Mich., showing magnet and other wire made by this company. F. L. Maske, president; Harry Simpson, sales manager; A. Maring and D. B. Colliver.

The Nash-Odell Company, of Chicago, showing their elaborate line, including some special novelties. The booth was handled by C. A. Nash, Irving Odell, C. W. Jones, H. A. Everett, J. Pomy, Robt. Weston and Frank Doherty.

North Shore Radio Works had an attractive exhibit showing their soldering iron. The booth was in charge of T. B. Wangeman and O. F. Fricke.

Philadelphia Storage Battery Company, showing Diamond Grid batteries. G. M. Netling, H. W. Stoltz, J. N. North, E. H. Stupp and E. W. Shepherd.

Post Electric Company, of New York, showed their soldering iron, the booth being in charge of Richard C. Allen, of the New York sales force.

The Postal Telegraph & Cable Company had a booth for handling messages under the charge of Miss Etta Weinstein and Abe Pommitich.

The Ra-Di-Co. organization had one of the busiest booths at the Show, displaying a complete line, featuring Paragon and Acme fone and sets. In the booth were the following: Ralph S. Drummond, Pres.; C. N. Hawthorne, Vice-President; Royal Stemm, Treas.; Philip Henderson, Sec'y.; Ross Regan, John Kinsella, G. P. Wurster.

Radio Age was represented by Fedk. Smith, editor; M. M. Smith, publisher; F. R. D. Pearne, technical editor; Harley V. Ward, advertising manager; H. J. Curran and H. Kier, of the circulation department.

Dealers!

Why scatter your purchases among many different concerns? We can supply everything essential to successful radio operation—each and every article standardized and backed by the manufacturers' absolute guarantee. Your detail work will be simplified and money saved by purchasing all your equipment from us.

Among this month's specials:

12,000 Ohm Resistances
.1 Henry Choke Coils

for Armstrong's Super-Regenerative Receiving Sets, accurately tested in our own laboratory.

Write for our price list

**RADIO & MECHANICAL
TRADING CORP.**

23 Warren Street Barclay 0926
NEW YORK CITY

The Gelman Plug



The GELMAN UNIVERSAL RADIO PLUG fills a long felt want for a simple substantial plug which can be used with telephone cords having pin tips, spade tips or plain wire ends. All METAL PARTS heavily nickel plated. NO SOLDERING NECESSARY. List price, \$1.00.

Manufacturers of

The Gelman 23 and 43 Plate Condensers
Jobbers and Distributors
Write for Our Proposition

S. S. NOVELTY CO.
255 Bowery New York, N. Y.



"True-Tone"
SUPERSENSITIVE
3000 Ohms

Worth More, Yet
Costs Less

"True-Tone" SUPERSENSITIVE Phones are of finest construction and are rigidly tested for Radio needs. Black moulded composition cups and caps. Head band is web-covered and adjustable.

Just what the name implies—"True-Tone." Perfect in performance for Crystal or Tube Sets and for Loud Speakers.

Every set is backed by a written guarantee of quality and satisfaction to the customer.

Sudden Shipping Service assures quick stock turn-over and profits. Discounts are more than liberal—you will be pleased.

Up to the Highest Standard, yet sold at the Lowest Price.

\$5.00
List
3000 Ohms

Wire or Write—NOW—for Discounts

"TRUE-TONE" RADIO MFG. CO.
186 No. La Salle St. CHICAGO, ILL.

The Radio Club of Illinois, the social organization, registered visitors who were interested in their organization. The booth was presided over by W. G. Hjerstedt, chairman of the membership committee.

Radio Digest was represented by E. C. Rayner, publisher; Harry Marx, technical editor; Frederick P. Ryan, advertising manager, and Sam Shapiro, circulation manager.

Radio Topics was represented by N. E. Wunderlich, editor; Jos. Novak, advertising manager; L. E. Kohler, circulation manager; L. E. Kohn, M. D. Kohler and Miss Bessie Smith, secretary.

Radio Units, Inc., of Chicago, showing some late ideas in self-contained sets, without outside aerial or ground, held the interest of the crowd continually. In the booth were E. F. Andrews, president; Frank Johnson, vice-president; Marvin Johnson, secretary.

The Raymond Radio Corporation, of New York, displayed their late type models, the company being represented by C. M. Hunt, sales manager; E. H. Kuttner and H. J. Swartz, the latter two having charge of the Chicago office of this company.

A combination of their portable loop aerial, three-tube Knockdown set and Thorophone loudspeaker produced undistorted signals which were audible 200 feet from their booth. Its instant popularity gave rise to the nickname of the "Knockout" set by the visiting buyers. Quantity orders were obtained from Florida to San Francisco.

A. H. Redden, Newark, N. J. occupied one of the liveliest booths of the show, located on a busy corner. There seemed to be always a crowd in attendance. Present in the booth were Mr. and Mrs. A. H. Redden, A. Shirk and S. Stollar, all of Newark.

Schreuder-Lockwood Press. A. N. Schurer, F. L. Lockwood and F. L. Ballinger, of this company, displayed the plan books on radio hook-ups that they have recently issued.

Harold M. Schwab, Inc., of New York, showing the Drisco line, of which they are exclusive distributors, occupied two booths in charge of Mr. Schwab and J. R. Wren.

W. C. Shinn Mfg. Co., makers of Shinn Amplitone antenna, lightning arresters, were represented by W. C. Shinn, G. L. McCall, L. H. Greenwood and N. W. Caldwell.

States Radio Corp., of Chicago, displayed an elaborate line of audio frequency sets in several tastefully decorated booths. Present at the show were: J. M. Hayes, sales manager; J. E. Marshall, assistant sales

manager; Anatol Gollos, chief engineer, and F. L. Damarin, assistant chief engineer.

The United States Naval Training Station at Great Lakes, Ill., was represented with an attractive double booth.

Underwood and Underwood, official photographers for the show, were represented by C. T. Underwood, Geo. C. DeCook and Frank Marshall.

The Western Union Telegraph Company had an attractive booth demonstrating some of the late ideas in the transmission of messages by wire. In attendance were Don R. Shiner, Theo O. Pawlicks, Genevieve Bohn and Mildred Huber.

The Weston Electrical Instrument Company, of Newark, N. J., occupied two booths showing their elaborate line of special electrical instruments. In attendance were C. F. Mueller, H. C. Silldorff, Paul Westburg, L. C. Herrmann and H. M. Poust.

The Westinghouse Electric & Manufacturing Company, Station K. Y. W.

Winkler-Reichmann Co. of Chicago had an attractive booth showing the Thorophone. The booth was in charge of T. E. Morrison, E. S. Riedel and Frank Reichmann.

Wireless Corporation of America had one of the most attractive booths at the Show, exhibiting their extensive lines of parts. In the booth were: L. Mandel, President; H. Mandel, Sales Manager; E. J. Burger, Supt. of Plant; E. S. Showers, in charge of Assembly Division.

THE "SUPREMO" INTERIOR ANTENNA

Pat. appld. for

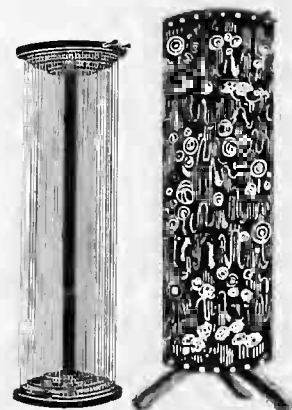

The most effective inside antenna on the market. Perfected by long experimenting under differing conditions. Loop or Ground connection. Can be used as a small stand. Supreme in reliability and efficiency. Price: \$8.00 and up. Dealers, get our sales proposition.

H. Ploug Mfg. Co.
130 W. 42nd Street New York

Radio Convention

First Annual Meeting of National Radio Chamber of Commerce

The National Radio Chamber of Commerce held its first annual meeting at Washington, D. C., July 26, 27 and 28th, 1922, at the Wardman Park Hotel, for the purpose of electing officers, governors and the various committees.

The principal speakers were announced as Honorable Herbert Hoover, Secretary of Commerce, who was scheduled for the opening address; Honorable John Wingate Weeks, Secretary of War, "Radio Preparedness"; Major General George O. Squier, Chief Signal Officer of the Army, "Military Value of Cooperation in Standardization"; Dr. S. W. Stratton, Director Bureau of Standards, "Standardization-Research and Its Influence on Commerce"; M. C. Rypinski, Vice President C. Brandes, Inc., Formerly Head Radio Division, Westinghouse, "Broadcasting"; Com. S. C. Hooper, Head Radio Division Bureau of Engineering, Navy Department, "Value of Manufacturing Organization in National Emergency"; W. Kaempffert, "Education by Publications and Conventions"; Howard Lewis, Business Manager, "Electrical Merchandising," "Electrical and Radio Merchandising"; Arthur Wiesenberger, Head Research Division, National Retail Dry Goods Association, "Marketing and Merchandising"; William H. Davis, Pennie, Davis, Marvin & Edmonds, "Patents and the Radio Industry"; Dr. Louis du Plessis Clement, "Broadcasting."

ROYAL LABS. EXPAND

Because of the great demand for "Royalphones," the Royal Electrical Laboratories, of Newark, N. J., have converted all the office space in their structure at 179-191 South Street into factory area. The office force has moved to another building at 207 Market Street, where H. L. Denburg is in charge of sales and advertising. An intensive advertising program will be conducted from the new quarters during the year with the idea of educating the consumer and dealer as to the superior qualities of the "Royalphone."

A new model of the "Royalphone" is ready which has four attributes designed to appeal to the radio buyer, attractive appearance, light weight, clear tone and moderate price.

NEW COIL MOUNTINGS

New single, double and triple coil mountings suitable for use on one of the most revolutionary developments in Radio, the Armstrong super-regenerative circuit, are made by the Astorloid Manufacturing Co. of 416 Marcy Ave., Brooklyn, N. Y.

These coil mountings are adjustable, made of genuine Formica, with high polish and finish. All metal parts are heavily nickel-plated.

Several patented devices are exclusive to the Astorloid coil mountings. Among them is the lock which holds the coil in place. This prevents the coil from being thrown out of adjustment once the station is tuned in. The tension of the specially constructed bearings is adjustable. Each of the three types mounts on the front of the panel. There are no rear mountings.

The Astorloid Company also makes a complete line of unbreakable dials.

The list price of the single coil mountings is 55 cents; that of the double coil mounting is \$3.50; and of the triple coil mounting \$5.00.

100% Radio

Altadena Radio Laboratory

560 E. Colorado Street
Pasadena, Calif.

Jobbers of All Standard Radio Apparatus, including

A-C Electrical Mfg. Company
Acme Apparatus Company
Adams-Morgan Company
American Hard Rubber Company
Automatic Electrical Devices Company
Nathaniel Baldwin, Inc.
L. S. Brach Supply Company
Burgess Battery Company
Blank Radio Call Book
Central Radio Laboratories
Edison Storage Battery Company
Everett Electric Corporation
Federal Telephone & Telegraph Company
General Apparatus Company
General Radio Company
Jewell Electrical Instrument Company
Colin B. Kennedy Company
Magnavox Company
Karlowa Radio Company
Parkin Mfg. Company
Radio Corporation of America
John A. Roebings Sons Company
Splitdorf Electrical Company
Thordarson Electric Mfg. Company
C. D. Tuska Company
Western Electric Company
Westinghouse Electric & Mfg. Company
Weston Electrical Instrument Company
The Wireless Shop

PAUL FRANKLIN JOHNSON

STERLING

SUPERSENSITIVE

HEAD SET

FOR COMMERCIAL
AND PRIVATE
RADIO SERVICE



The Sterling 3000 Ohm Supersensitive Radio Head Set gives a loud, clear tone and embodies the very latest mechanical and electrical features of head-set design. Replaceable, sanitary patent leather covering for head piece. Exceptionally comfortable to the ear.

Guaranteed to give satisfaction.

Write for discounts and get your order in early

List Price

\$7⁵⁰

STERLING DEVICES CO.

Manufacturers of celebrated line of Sterling Phonograph Reproducers
1819-21 Carroll Ave.

Chicago



Tresco RADIO

Licensed Armstrong U. S. Pat. 1,113,149

Tresco Receiving Sets have been giving satisfactory results in all parts of the world for the past seven years.

Jobbers and dealers will find in Tresco everything that makes a connection profitable. Prompt shipment—reliable merchandise backed by National Advertising. Write for our discount list.



SHIPPED FROM STOCK

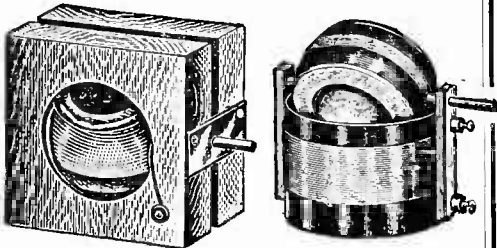

Prices Net to Dealers Only

- Variometer, complete\$2.00
- Variometer Parts, all necessary parts except wire..... 1.00
- Variocoupler, complete 1.50
- Variocoupler Parts, complete set of parts, except wire.... .85
- Thordarson Amplifying Transformer 2.75

Scientific Dealers Supply Co.
2727 Fullerton Ave., -- Chicago, Ill.

INSIST FOR REPRODUCING

CRYSTAL

UNCONDITIONALLY GUARANTEED

'PHONE FIXED

CONDENSER

LIST PRICE \$.75

REPRODUCING CRYSTAL

DETECTOR

IT HEARS THE WEAK SIGNALS
LIST PRICE \$.90

SWITCH LEVER

COMPOSITION KNOB—HIGHLY NICKLED

LIST PRICE \$.40

IMMEDIATE DELIVERY

INSIST ON DUGDALE PRODUCTS

DUGDALE LABORATORIES

55 HALSEY STREET
NEWARK, N. J.

Loud Speaker

Thorophone Is Result of Pioneering in Sound Magnifying

The Thorophone is a new radio loud speaker put on the market by the Winkler-Reichmann Company of Chicago. The Thorophone comes in two types the "S" type and the "K" type. The "K" type is a small watch case, permanent magnet, loud speaking receiver with mica diaphragm. The "S" type is an electric magnet solenoid, operating the mica diaphragm.

The manufacturers of the Thorophone claim wonderful tone quality for their loud speaking receivers. They were elaborately demonstrated at the Radio Show at the Leiter Building, Chicago, and the opinion of the visitors at this show was to amply verify these claims.

The Winkler-Reichmann Company have been in the business of manufacturing loud speaking telephones for paging purposes since 1914 and the men of the technical staff have been identified with this work for a number of years previous. Their paging systems are used extensively throughout the country for paging purposes in large business houses, railway stations, hotels, clubs and hospitals. The principal hospitals of the country are equipped with this system which is used for locating visiting doctors, internes, and nurses. Among their many interesting installations is that of one hundred and ten horns on the battleship U. S. S. California. It is interesting to know that the Navy is using such a modern method for giving general orders on floating fortresses.

It is interesting to note that the Thorophone has for its sound reproducer a sound box mechanism and diaphragm construction practically the same as that used in the phonograph art. A close parallel here would seem logical. The manufacturers of phonographs have been striving for twenty years to improve this construction but apparently have only made minor improvements or

changes. It is logical to assume that this represents the highest development in this art and that unless some radical new principle is discovered that phonograph quality will be the standard by which to gauge loud speakers for some time to come.

The horn used in connection with the Thorophone loud speaker is interesting from an acoustic standpoint. Instead of the tone arm being of metal, the throat of heavy castings and the bell of wood as is the usual thing in a phonograph, the order is reversed. The concert horn has the wooden tone arm, a heavy cast throat

DIAMANT VARIABLE CONDENSERS AND DETECTORS

DIAMANT TOOL & MFG. CO., Inc.
93 Runyon St. Newark, N. J.

RADIO MAILING LISTS

We have just compiled a list of 6,900 Radio Dealers (none worth less than \$3,000) covering the United States. Price per M. \$7.50

707 Radio Manufacturers	List	7.50
726 Radio Supply Jobbers	"	7.50
260 Owners of Radio Stations	"	4.00
14,000 Radio Amateurs and Managers of Radio Stations	Price per M.	7.50

Neatly typewritten and ready to send on receipt of remittance covering the amount.

TRADE CIRCULAR ADDRESSING CO.
166 West Adams Street Chicago, Ill. nois
Franklin 1182-1183

LOOSE COUPLER RECEIVING SET

Type NT

Detroit Radio Company
1 West 34th St. New York

IMMEDIATE DELIVERY

DIALS

NEW YORK RADIO DIAL CO.

80 Beaver St. New York City

Dealers, Attention!

We are manufacturing high grade tuner detector units and three-stage choke coil amplifiers to match.

Write for exclusive dealer's proposition in your territory.

WIRELESS PHONE CORPORATION

193 Ellison Street

Paterson, N. J.

and a very heavy spun aluminum bell. This is a very substantially constructed horn. The arrangement of the materials is claimed to give a more accurate reproduction of the tone than the reverse found in a phonograph. It is claimed that the records on a phonograph are unnaturally high pitched and the horn is unnaturally low pitched. The combination gives the correct pitch for a phonograph.

In radio reproduction where every effort is made to give the correct pitch from the broadcasting station through the receiving set and through the loud speaker, it is necessary to have a horn of a correct pitch, not too high nor too low.

Both the "K" and "S" types may be used without the concert horn as they can be arranged to operate by means of an adapter furnished to mount in a phonograph and connected to a phonograph horn.

EFFICIENT DETECTOR

Designed by former engineers in the United States navy, the Aerex radio phone receiving set Model BR-1 is a crystal detector set of workmanlike appearance and results.

It consists of a primary circuit and a secondary circuit. The wave change switch picks up the approximate wave length and by the use of a variometer fine tuning is accomplished. This means that a maximum volume of sound is obtained, a feature rather unusual for a crystal set.

Added tuning is possible by the use of the coupler. This is particularly useful in eliminating interferences. The set is designed for radio reception up to 35 miles under ordinary atmospheric conditions. Telegraph signals from 200 miles have been received on the instrument. Messages sent on wave lengths of 150 meters to 600 meters have been caught by the Aerex set, the makers claim. With the addition of a specially designed Aerex loading coil it is said that messages of 1500 meters have been received. The addition of a two stage amplifier makes the reception radius more than 200 miles. The set is covered by the Aerex company's patents granted between the years 1908 and 1917. The receiving set without phones lists at \$20.00

ENTERTAINS BUYERS

Some of the New York retailers in the heart of the ready to wear section, report that they are selling quite a few high priced sets to the show rooms of the firms in this district. It is presumed that these sets are to be used to entertain out of town buyers who frequent these places.

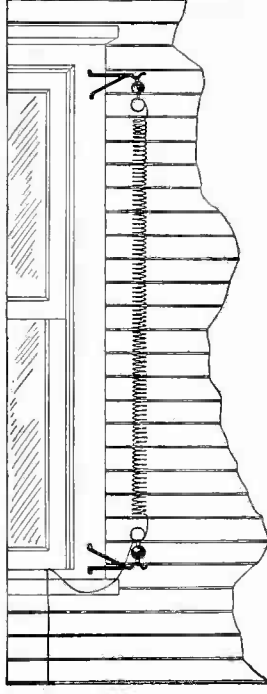

"K-N"
HELIX ANTENNA

Only 6 feet of space required to install
100 feet of wire

The "K-N" is adjustable to any space

The ideal aerial, made from ideal Antenna Wire

The "K-N" is a spirally wound aerial and is therefore adjustable to the available space, either on the roof, outside the window or within the home.

Jobbers and Dealers write for special discounts

Receptive area in all directions.
Remains taut—no swaying.
Installed with greater ease.

RETAIL PRICE, \$1.60

Manufactured by
WALTER S. KRENZ

339 So. Central Park Blvd. CHICAGO, ILL.



Jobbers Attention
THE FAMOUS CYCLONE
The World's Best B Battery
Each and Every One Guaranteed
STANDARD EVERYWHERE

Standard Electric Novelty Co.
324-8 Lafayette St. N. Y. City

Phone Harlem 3067 2378 Third Ave., at 129th St., New York City

SCHEUROTH LETONITE CO.



MANUFACTURERS OF
Radio Specialties

MOULDED PRODUCTS OF EVERY DESCRIPTION

Send in Your Blue Print Specifications

Prices on Application

HIGH HEAT RESISTANT

"LETONITE"

A FEW OF OUR STOCK PARTS

Delivery Immediate

ALSO MADE IN CONDENSITE, BAKELITE OR REDMANOL



"A Marvelous Invention"

—say experts

AN age-old principle of sound amplifying is the secret of the wonderful tonal qualities of the Sheltone Loud Speaker.

The Sheltone is shaped like a shell. At its base is an open tone chamber over which any two standard receivers fit. This chamber carries the sound to the curved surface of the Sheltone, causing each note to marvelously swell in volume.

No tubing to rob the sound of its fullness; no horn, as on ordinary loud speakers, to destroy or distort the most delicate notes. Every sound is true, sweet, mellow and distinct to everyone in the room.

Even if you have a loud speaker, it will pay you to learn the delights of a Sheltone. Your friends are sure to admire it. The Sheltone is **different** from any loud speaker on the market. Substantially made, highly polished; only 8½ inches high.

\$5

WITHOUT RECEIVERS

THE SHELSTONE COMPANY
20 CLINTON ST., NEWARK, N. J.



Important Patent

New Type of Variometer That Occupies Small Space

The term "variometer" is a coined name that has always been used by the radio fraternity for a continuously variable inductance. At the present time the majority of the wireless receiving sets make use of one or more of these devices, as the variometer is recognized by many as the most efficient tuning device that is known to the art.

However, any mechanism is subject to improvement of design. There is being placed on the market an improved type of variometer known as the Rogers Receiving Radiometer, embodying such simplicity of design that it will retail for two-thirds the price of the usual design. Yet it will function as well, if not better, than the ball type variometer with the additional feature of occupying but a fraction of the usual space necessary in the modern receiving set. It will appeal very quickly to engineers and designers because of the small space factor. First appeal to the amateur or new radio fan is very likely to be to the pocket-book, especially when finer tuning and better results may be obtained.

Ordinarily, a single stationary winding produces an electro-magnetic field, which is opposed or assisted by a similar electro-magnetic field from a movable winding mounted in close inductive relationship to the stator or stationary winding.

In this new design a pair of flat disks are substituted for the tubes and wooden rotors used heretofore, the magnetic fields being divided into two separate components. The stationary disk is clamped to a panel bushing with a single nut. The rotor or movable assembly, consists of a second disk clamped between nuts on a shaft held by the supporting panel bushing. The current is conducted through the two fields of the stator, which are in series, thence to the bushing, to the shaft, then out through two fields of the movable disk to a terminal near the center of shaft. A circular movement of 180 degrees gives a variation of inductance from a minimum value to a maximum value, depending on the amount of winding.

Each of the four windings are of "D" shape and are interwoven in slits around the periphery of the disks. It follows, therefore, that the wire is held in place without resort to paraffine, shellac, varnish or compound of any nature and as silk insulation is

THE PORTABLOOP



Size 24"x27" overall
Shipping weight 8 lbs.

The coming piece of apparatus for the farsighted and progressive dealer.

Order a sample.
List price \$10.00.
Liberal Discount.



212 Central Avenue

used the usual detrimental capacity effect between separate turns is practically nil which accounts for the wonderful efficiency and sharpness of tuning possible with this advanced type of variometer.

By using a single supporting bushing for the entire assembly which is also used for the electrical contact between the two inductors, it requires but a few moments for mounting, as only a single hole for the bushing need be drilled in the panel.

A special spring washer is placed on shaft before attaching the moulded knob and dial to complete the assembly. This washer serves to take up unnecessary play in the shaft, keeps the disks in close inductive relationship and provides the right amount of friction for a permanent adjustment.

Two sizes of bushing nuts permit mounting on any support from 1/8 in. to 1/4 in. thickness.

Patents are pending on the device, and large production is well under way. The trademark has also been registered in the U. S. Patent Office, namely "Rogers Receiving Radiometer."

ROBBINS' NEW SERVICE

The Robbins Electric Co. of Pittsburgh, who have been giving service to electrical dealers in the Eastern Central States for over thirty years, are attempting to inaugurate such a statistical service to the radio dealer. Peculiarly well situated for obtaining all manner of miscellaneous information on radio matters by reason of close contact with the Radio Corporation of America, the Westinghouse Electric & Mfg. Co., Herbert H. Frost and others, additional means of amassing a general knowledge of trade conditions are secured by periodical surveys of widely different territories made by competent field men. Thus the July-August Survey covered some states as yet practically unopened to radio; some regions where radio as a business is not as yet full-fledged; and other districts where the game has been going for years.

The data thus gathered is assembled; the reports read and compared with previous ones; and the whole edited by Mr. C. R. Harrison, Secretary of the firm, and member of various national radio committees. This analysis or prophecy—call it what you will—is then sent to each dealer with individual recommendations.

MUSIC AIDS RADIO

William A. Blair, of the Upham's Corner Music Store, Dorchester, Mass., says that the Radio Broadcasting of music has been quite a help to his business,

Binding Posts—Contact Points
and
VARIABLE CONDENSERS

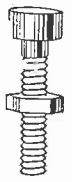

with patented adjustable tension

JOHN A. COZZONE & CO.

61 Arlington Street

Newark, N. J.

THE STORM-LEE MULTIPLEX ROTARY SWITCH

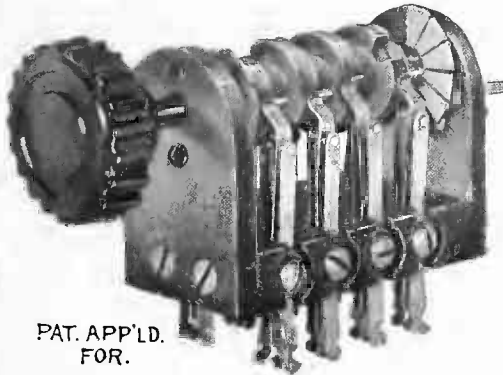

PAT. APP'LD. FOR.

The Perfect Amplifier Switch Gives Complete Control of Detector and 1, 2 or 3 Stage Amplifier, Including Automatic Filament Control.

The MULTIPLEX ROTARY SWITCH takes the place of filament control jacks in the vacuum tube control panel, giving much greater convenience at lower cost. With this switch you may change from detector to any desired stage of amplification by merely turning one knob. Filaments of unused stages being automatically extinguished.

UNIVERSAL IN USE

This switch is adjustable, by loosening one nut the cams may be adjusted to meet practically any switching requirements.

SPECIFICATIONS

- INSULATION—BAKELITE
- SPRINGS —NICKEL SILVER
- CONTACTS —STERLING SILVER

LIST PRICE - - - - \$5.00

Write for Discounts

JOBBERS—DEALERS

This switch is revolutionizing amplifier construction, owing to convenience of operation. It will be to your advantage to write for our attractive proposition.

MANUFACTURERS

Why not use this switch in your sets? Write for details.

STORM-LEE RADIO APPARATUS CO., 740 Highland Avenue, Newark, N. J.

Read This Ad Once, Twice, And Then a Third Time

DEALERS AND JOBBERS

Do not plunge; do business with specialists in the radio field; a conservative company that desires to retain your good will and trade by supplying you with the best at the least cost, yet allowing you a generous profit.

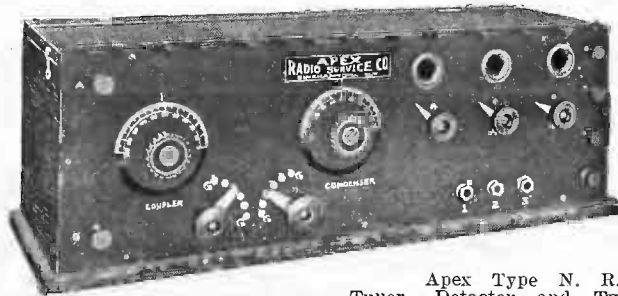

Apex Type N. R.-1, consisting of Tuner, Detector and Two-Step Amplifier. This set is the outcome of ten years' study in the radio field, is a guaranteed product and the low price of this high quality unit will amaze you.

APEX RADIO SERVICE CO., Manufacturers

705 Press Building, Binghamton, N. Y.

Write for Our Interesting Proposition

Want to Buy Radio Equipment?

Ask Our Service Bureau

See Page Eight

Radio Salesman for exclusive territory to sell to jobbers only. Nationally advertised phone set. Write, giving full selling experience.

Royal Electrical Laboratories
207 Market Street Newark, N. J.

Prompt Deliveries

Jet black high finish panels, .01 per inch, 3" nonbreakable, flexible dial with knob\$.70
3 1/2" Vario-Coupler.. 2.00

The above are net prices in quantities

Beau Ivorie Novelty Co., Inc.
127-129 Van Buren Street
Newark, N. J.

LOOK WHAT WE HAVE TO OFFER
Variable air condensers, no junk, 43 plate, list at.....\$4.00
Variable air condensers, no junk, 23 plate, list at..... 3.00

Discount, 50% of the list price.
Rheostats and Bulldog Plugs for immediate delivery.

Ducon aerial plugs and Novo Batteries, always on hand.

TUBES
UV 200 and UV 201, U. S. Signal Corps Tubes, VT 1 and VT 2 also in stock.
Western Electric Loud Speakers and Magnovaxs.

Liberal Discounts to Dealers
Small orders receive the same attention as large orders.

Write—Wire
WHITE RADIO CO.
141 West 33d Street New York City

P. D. JACKSON

Direct Factory Representative
Radio Equipment Manufacturers
HEAD SETS A SPECIALTY
1441 So. State Street Chicago, Ill.

“SIMPLEX”

(The Aerial Eliminator)

Does away with Static
RETAILS **\$1.25**
FOR

C. Bisgard & Co.
Suite 610
1476 Broadway, New York

MACHEN ENTERS RADIO

Machen Radio Manufacturing Company has been formed to manufacture Radio apparatus and is now in production on the following devices:—

Filament-rheostats, variometers and vario-couplers with wood and composition rotors and stators, complete line of telephone jacks, telephone plugs.

They are bringing out a very high grade telephone head set of 2400 ohms resistance, and will have on the market, shortly, crystal detectors, lamp sockets, and dials. Machen Radio Manufacturing Company is connected with Machen Electric Manufacturing Company, manufacturers of wiring supplies, and is under the management of the officers of the latter company.

COIL HAS MANY USES

A three slide coil tuner wound with high grade enameled copper wire is made by the Gem Radio Manufacturing Company of New York.

An important feature of this tuning coil is that the slides are fitted with a small roller, so that it is possible to establish contact with only one turn of the wire at a time. Used as a tuning coil, this Gem three slide instrument will tune to receive wave lengths up to 2,000 meters, according to the makers' claim. By varying the position of two of the sliders and using the third, the effect of a loss coupler is obtained. The coil may also be used as a loading coil.

The Gem Radio Company also make compact and complete crystal detector sets, vacuum tube sets and variometers.

JOBBER WANTED

The Aronax Radio Sales Co. of Chicago, Ill., have secured the sole sales right of the Sun Radio Co., manufacturers of the Sunset Tuner and Detector. This little set lists for \$11.00 and tests have proved that it will receive upwards to 200 miles. The Company is now assigning territory to various jobbers around the country. There is no doubt that the profit returns will be very great for those who handle this Sunset, the Aronax Company believes.

EXPANDS NATIONALLY

The Radio Equipment Service, 500 Fifth Avenue, New York, announce that they are now branching out into a national field. Formerly exclusive mail order distributors, the company is now prepared to handle a complete line of radio equipment through the regular channels. “Radiolite,” the company's new cabinet radio set, is to be distributed nationally.



A. H. Redden

As a distributor of nationally-known Radio lines, A. H. Redden, of 1096 Clinton Ave., Irvington, New Jersey, is featuring the Jenkins Rheostat in his line.

The Jenkins Vacuum Tube Rheostat, Type A, is designed to simplify the receiving of continuous wave and distant signals. It is said to give the closest possible control of detector and amplifier tube filaments, which means finer detection of all signals and a greater radius of action. Head phone noises are done away in the Jenkins Rheostat, makers say, because of smooth operation in the changing of resistances possible in this instrument. The capacity is two amperes and the total resistance is 12 ohms.

A GOOD FAN

The Egyptian Radio Bugs, an organization of radio fans in Southern Illinois, are publishing the Egyptian Radio Broadcasting News, a four pager, every Saturday, edited by Fay Luster, chief radio bug of the association. The first issue is a neat one, replete with items that interest radio fans.

MANUFACTURERS' ASSOCIATION BEING FORMED

A national association of manufacturers of radio and allied products, it is said, is being organized in New York, following a recent meeting.

Those present at the meeting represented the following concerns: American Radio and Research Corporation, Dubilier Condenser and Radio Corporation, Crocker-Wheeler Co., Horne Mfg. Co., Electrose Mfg. Co., Callaphone Co., Scranton Button Co., and Clapp-Eastham Co.

Radio Guild Makes "Set with the Human Voice"

Guild's Portable Set Creates Sensation When It Reports Fistic Battle to the Life in Restaurant

By J. McKERCHAR

A great deal of interest has lately been evinced amongst the dealers and radio enthusiasts in general in the doings of the Radio Guild. Although this organization has not been in the field very long, the products which they have put before the public have won for them immediate recognition. These products indicate that the men behind the Radio Guild have a long acquaintance with radio requirements and know their public. The first of these was the "Vox Humana." This was first exhibited at the New York Radio Show at the Seventy-first Armory. In this receiver the first really successful application of radio frequency amplification in a commercial product was obtained. The design was entirely original in that the instrument was completely self-contained. The loop is wound on a frame inside the cover and can be turned at any angle to take advantage of its directional properties without moving the cabinet. The necessary batteries are inclosed in the left hand compartment. The cabinet itself is a beautiful piece of furniture, which would grace any refined surroundings. It is not in the least spectacular or glaring. The Radio Guild seems to have realized that people who buy radio instruments of this high-class type for their homes would not desire a gaudy affair to jar an artistic taste or be out of keeping with the subdued harmony of a modern home.

This receiver is particularly intended for those who live within fifty miles or so of a broadcasting station. It is not primarily intended for long distance reception although it can be adapted for this purpose. The designers, however, have correctly estimated that in this class of receiver it

is better to specialize on loud, distinct reproduction of radiophone broadcasts free from all noises and disturbances. These results are best obtained when a loop is used in place of an outside aerial and depend upon the design of the amplifying apparatus and the correct type of loud speaker. These details have been carefully considered by the designers of the "Vox Humana," and the results which have been achieved are remarkable. Since a loop is used for reception the range in miles is necessarily limited, but when the receiver is located within a reasonable distance of a broadcasting station the reproduction is unique in its perfection. The voice is so pure and natural that this instrument has truly been called "the receiver with

A subsequent product of the Radio Guild is the portable R. G. 500, a photograph of which appears on this page. This receiver incorporates all the remarkable features of the "Vox Humana" in the small space of a suitcase. This was recently demonstrated to the amazement of a crowd in a New York Restaurant. A representative of the Radio Guild walked into the restaurant and after asking the manager's permission to demonstrate, calmly laid the suitcase he was carrying on a chair, pushed a switch and made a few adjustments. Immediately the restaurant was filled with the shouts and yells of the ringside at which Leonard and Britton were battling for the world championship. The clangs of the bell and the shrill voice of the referee were plainly audible. The announcer in loud clear tones gave details of the fight as it progressed. Then the fight ended and WJZ had signed off, the Radio Guild representative switched off the filaments, lifted the suitcase and walked away.

The Radio Guild has also perfected a complete line of tuners, radio frequency amplifiers. One of these is a complete unit with two stages of radio frequency, detector, and three stages of audio. Other units comprise radio frequencies amplifiers with detector, short and medium wave

tuners and audio frequency amplifiers, all in units of the same height so that any desirable combinations can be made.

One of the biggest sellers of the Radio Guild this coming season will be the complete short wave tuner and detector outfit which they are preparing. Everything necessary for reception will be included and the price will be exceedingly reasonable.

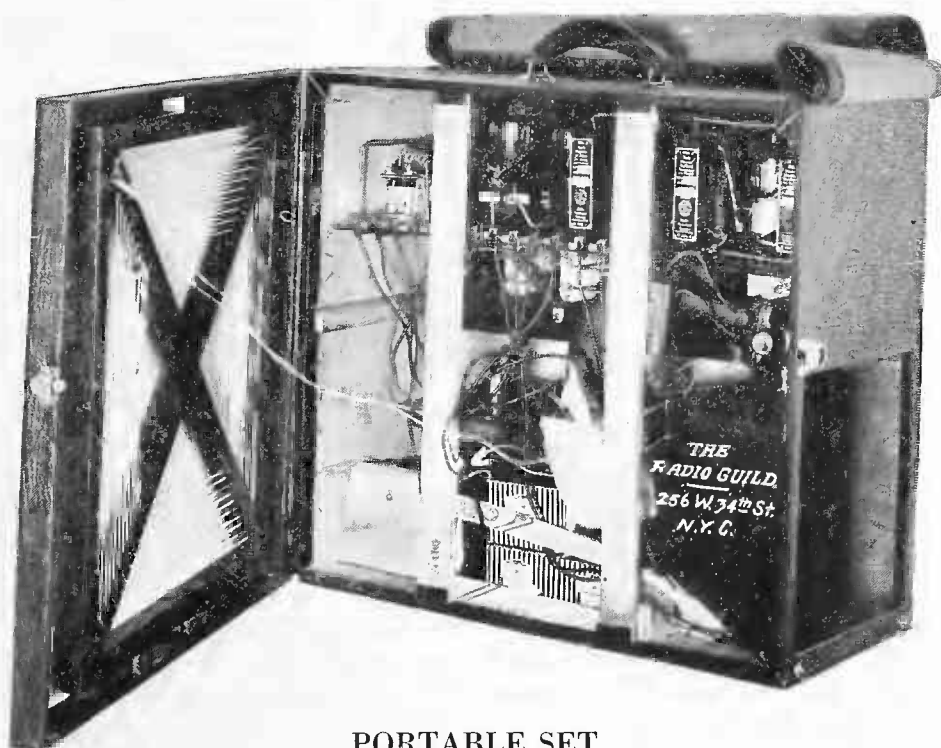

PORTABLE SET

Made by the Radio Guild, has all the qualities of the "Vox Humana," with added convenience of portability

the living voice." Unless there is a thunderstorm overhead, static does not seem to affect reception in any way, and there are absolutely no hissing, frying, or other unwelcome noises. When the transmitting station ceases, not a single crackle or hiss emanates from this instrument. The tuning is extremely simple and the filaments of the vacuum tubes are turned on and off with a single switch.

Tillman RADIO PRODUCTS

DESIGNED by engineers in our Laboratory, and made by instrument makers in our Shops, we guarantee our instruments to be exactly as represented in our descriptions.

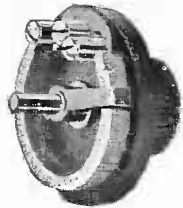

POTENTIOMETER

For regulating plate voltage, the resistance unit is shunted across the filament battery while the contact lever is connected to the negative side of the "B" Battery.

For maximum voltage amplification when using radio frequency transformers, the resistance unit is shunted across the filament battery, while the contact lever is connected to the secondary of the tuning apparatus on the filament side.

Resistance unit is wound to 200 ohms on treated hard fibre and force fitted into a highly polished BAKELITE base. Contact lever is phosphor bronze and makes contact on the periphery of the unit, *not on the top*, thereby giving absolutely smooth, noiseless adjustment.

Knob is of hard rubber, tapered and highly polished; indicator is of brass, nickel-plated and hand polished.

The current consumption of this type Potentiometer is almost negligible—with Radiotrons about .03 amperes, with Meyer's III Mu Tubes, about .02 amperes.

LIST PRICE.....\$1.65

Also: V. T. Sockets, Rheostats, Audio Frequency Transformers, Universal Radio Plugs, Radio Frequency Transformers, Balanced Type Variable Condensers, Head Sets, 3000 ohms (Millardians) and other items.

Catalog Mailed on Request

WM. J. MILLARD & CO., Inc.

MANUFACTURERS

189B LAFAYETTE ST., NEW YORK

Lately the Radio Guild has published a booklet by Kenneth Harkness giving complete and detailed information concerning the new Super-Regenerative Receiver. This booklet gives numerous diagrams together with photograph of two sets actually constructed by the author. This booklet undoubtedly gives authentic and reliable information regarding the Super-Regenerative Receiver. The original set constructed by Mr. Harkness was recently exhibited in a New York store. Using a small loop a Western Electric loud speaker was operated without any power amplifier. The signals were exceedingly loud and demonstrated that the set embodies the principles outlined by Major Armstrong. The Harkness booklet has been a big seller amongst the radio dealers.

The Radio Guild also supplies knocked down super-regenerative receivers constructed in accordance with the instructions contained in the Harkness booklet.

MONTCLAIR'S STANDARD

The Montclair Standard is a non-regenerative receiving set manufactured by the Montclair Radio Manufacturing Corporation, of 657 Bloomfield Ave., Montclair, N. J.

Features of the set which retails at \$35.00 are: Invisible binding posts, all wires being brought to the rear of the cabinet; quarter oak hand rubbed cabinet, with hinged top and removable base, upon which all parts are assembled; genuine Bakelite-Dilecto panel; unbreakable dials with large characters tuning range from 150-750 meters; quiet operation; no distortion.

NEW CRYSTAL

Announcement of a new Radio crystal for crystal sets sensitive all over is made by the Ford Mica Company, 14 Christopher Street, New York.

This new composition is being used at present by the Westinghouse, General Electric, Sonora Phonograph, and Western Electric.

The Ford Mica company also carries a full line of parts for regenerative sets and crystals. All the work of the company is under the direct of supervision of Mr. Sharp, who has been in this line for years.

LOOK OUT FOR SWINDLER

The Melchior Equipment Co., of 306-308 East 34th Street, New York City, is sending out a letter to the trade announcing the fact that they will not be responsible for any debts contracted by persons who have no connection with them.



ALCEMO

Sensitive Head Sets

YOU wouldn't sell your customers a *pint* measure when they ask for a *gallon* measure—yet many radio head sets are being sold today which will not test up to the ohmage they claim.

The Alcmemo Sensitive Head Set is guaranteed 4,000 ohms or *more*—never less.

This perfected radio phone sells at only \$10.00. It will detect the faintest signals on the longest distance work any receiving apparatus can bring in.

The amateur in progressing from the small, cheaper receiving apparatus to the more expensive, will



never have to replace his Alcmemo Head Set—the Alcmemo gives perfectly clear, musical tones on all ranges, and is guaranteed to retain its sensitive qualities permanently.

The day of undependable radio products is over. Alcmemo Head Sets meet every test of price and quality—fill out the coupon below for full information.

Alcmemo Manufacturing Co.

Newark, New Jersey

ALCEMO MANUFACTURING CO.
Newark, New Jersey.

I am interested in your guaranteed 4000 Ohm Head Set to retail at \$10.00. Please send details.

Name
Address

MANUFACTURERS
JOBBERs —

Have You Seen
The Radio Dealer
WEEKLY
?

This weekly folder issued by the Service Bureau of The Radio Dealer lists inquiries of dealers all over the United States and Canada

SEND FOR SAMPLE COPY TODAY

Service Bureau

THE RADIO DEALER

1133 Broadway

New York City

Gregg and Company New Radio Engineers

An interesting development in the radio field has recently had its beginning in the establishment by Gregg and Company, a well known firm of New York engineers, of a department devoted to this particular activity.

These engineers, recognizing the great possibilities of radio evolution, have developed a specialized service which is designed to afford the manufacturer, the dealer and the purchaser, the benefit of the same engineering principles and practices which have been applied to such other efforts as the establishment, management, re-organization, etc. of industries and the design and construction of industrial units.

The service covers practically the entire field of endeavor, including the design of radio sets and parts, as well as the tools and dies for their production.

The well equipped testing laboratory is expected to fill a long felt need for reliable standards for the valuation of radio equipment. The laboratory will,

of course, undertake the usual measurements of capacity, inductance, etc. Its main purpose, however, is to establish standards with which equipment sent in for test will be compared. The results of the test will be expressed in numbers wherever possible.

The company feels that at present even the experienced purchaser of radio equipment is groping in the dark. There is no more difficult problem than to establish the degree of efficiency for radio instruments. The service which Gregg and Company have developed is designed to enable the manufacturer to sell his equipment with a certificate indicating its efficiency, backed by an established organization. The purchaser will be able to either require a certificate of the manufacturer, or he may have the samples offered and the equipment delivered in fulfillment of contract tested for purposes of comparison. He will in this way be entirely protected against goods of doubtful design, workmanship or material.

States Radio Corporation



501 So. Jefferson St.
Chicago

Manufacturers of
High Grade Equipment

Jobbers and Retailers

A Quick-Money Proposition for You

2 Stage Radio Frequency Detector.
2 Stage Amplifier.

Each in a handsome mahogany case.
No wiring to do.

Tunes to all wave lengths, local and long-range.
Very clear.

Just what the Public is hungry for.

Immediate Delivery

Send for List and Discounts

Maclite Vario-Coupler

Price \$5.00

Is, in the opinion of experts, the most efficient on the market.

All Other Maclite Parts are equally efficient, including the Maclite Variometer, Double Slide Tuner, Variable Condensers and Crystal Detectors. The Maclite Single Tube set at \$25.00 is the best buy we have ever seen. Let us tell you more about this set, also all other Maclite parts.

Dealers and Jobbers Write for Discounts

MACLITE RADIO CO.

701 Maclite Bldg., Claredon St.
Boston, Mass.

Ask Our Service Bureau

JESRAD VARIABLE CONDENSERS

Plain type or with
Vernier Attachment

43 Plate.....\$3.50
23 Plate..... 2.80
11 Plate..... 2.60

Without dials or knobs

Every condenser which leaves our factory is put under the most rigid test and is GUARANTEED to give absolute satisfaction.

Dealers and distributors write for special discounts.

Jesser Radio Sales Co.
538 So. Clark St. Chicago

DISTRIBUTORS
American

Electro Phone Company, Inc.
512 Fifth Avenue, New York
Phone Longacre 8995
Discounts to Jobbers and Dealers

UNIVERSAL BATTERIES

The heart of a battery is its plates, is the idea behind the Radio batteries being manufactured by the Universal Battery Company of Chicago. All four styles of batteries designed by this company for Radio Service have plates of the same thickness, 3/16 of an inch for positive plates and 5/32 of an inch for the negative plates.

All four styles are portable, and differ only in the containers. The weight of the batteries ranges from 40 to 50 pounds. Type WR Radio Battery is assembled in three hard rubber jars that are sealed and placed in a hardwood case finished in mahogany. Type RR is in a hard rubber combination case, compact and acid proof. The jar holding this battery is jet black. Type RCR is a three compartment composition case. The cover conceals all metal parts and is easily moved when necessary. A bucket type handle is solidly attached to the side of the box for this purpose. Type GR is assembled in three glass jars, sealed and placed in a wooden crate of mahogany finish. Plates and other parts of the cells are visible, allowing for absolute care of the battery. This type is similar to that used in farm lighting plants.

CORONA SR.

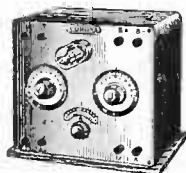

Price \$30

Attractive discounts in quantities
A Dependable Vacuum Tube
Receiving Set
Immediate Deliveries

CORONA ELECTRIC
CORPORATION

Radio Division
265-7 CANAL STREET, New York
Telephone: Canal 0015

APARTMENT HOUSE RADIO

A choice of "listening in" to either of two programs being sent out by the big broadcasting stations will be a feature of an unique radio system being installed in a 72 family apartment house in Newark, N. J. by the Davis Electric Company. Two complete receiving sets will be installed, each with a large loop or directional aerial, pointed to a particular broadcasting station and the program received without interference from whatever may be coming in on the other loop.

A special radio room in charge of a licensed operator will house the equipment. From this room will emanate two complete circuits connected to each of the 72 apartments and so arranged that the tenant may plug in his receiving set to whichever of two programs he may prefer. The apartment operator will tune in each evening to the two stations that offers the best programs or are heard the clearest and in this way the tenants will be able to enjoy the best in the ether each night with the least of trouble.

Two complete G-E receiving sets, of the type furnished by the Radio Corporation of America, each equipped with a detector tube, two stages of audio and two steps of radio frequency, will be installed.

MAIN, RADIO PIONEER

Murray E. Main, President of the Main Electric Company, Cleveland, Ohio, makers of farm power plants, experimented early in the history of Radio. Back in 1904 he personally built a four inch spark coil and a 10½ inch Tesla 250,000 volt coil came from his hands in 1905. He predicted at that time that the wireless telephone would be a commonplace within two decades.

"Now," he says, "with the very latest findings of Major Armstrong on his super-regenerative circuit, selectivity of within a half meter, we have the greatest step in advancement since the invention of the radiophone itself."

At present Mr. Main has established the Main Radio Corporation which is now producing complete receiving sets consisting of three separate units in genuine solid mahogany cabinets finished in natural color with hand-rubbed finish. Panels are of black formica. The turning unit consists of a 23 plate Vernier condenser with a three inch dial, another Vernier condenser with a knob for finer adjustments, 180° variocoupler, with formica tubing, green silk-covered wire, heavy brass frame and mountings with gauze brush contacts. The other units are of equally high grade design and equipment.

PREMIER DUPLEX PHONE

A new head set of unique design, having all the adjustments of the ordinary outfit, and an added feature of a means of splitting the set into two parts exactly alike, each part having a fork to which the ear phone is attached, a padded clamp for height adjustment, and a strip over the head for holding the phones in place, is being marketed under the trade name of Premier Duplex. It is the invention of W. G. Viall of Paterson, N. J., who anticipates obtaining some very strong patents on the several new features involved. Mr. Viall is an Electrical Engineer of over twenty-five years' experience and has devoted the major portion of his time to the design and manufacture of electrical apparatus. Through his association with the Premier Accessory & Specialty Corp., 29B Congress St., Newark, N. J., who are manufacturers of some very High Grade Apparatus, the Premier Co. have taken up the manufacture of the New Head Set under the direct supervision of Mr. Viall. Other radio apparatus will be added in the near future so as to eventually place in the market a complete line of Premier

Products all of which will carry the Premier's absolute guarantee of quality.

The padded clamp for height adjustment eliminates the scratching of the nickel plated parts, a slight pressure of thumb and fore-finger is all that is necessary to make the adjustment and it will not change in taking the head set off or putting it on. The pad keeps the nickel bright and tends to maintain the beautiful finish of the whole outfit. The flat metal parts are finished in black enamel, the trimmings are bright nickel, and the overhead strips are covered with a finely woven soft brown sleeving tipped with black binding. The head band is said to be one of the most convenient and comfortable as well as the neatest and most serviceable yet produced. The ear phones have comfortable caps, drawn aluminum shells, rust proof diaphragms of special quality iron, norway iron cores, varnished cambric insulation, enamelled copper wire windings, tungsten steel magnets. The coils are wound on automatic winding machines insuring uniform winding without cross wires or short circuits.

DEALERS

Full Line of Radio Supplies Most in Demand

IMMEDIATE DELIVERY

Genuine DE FOREST Apparatus

All Coils and Mountings Required for

The New ARMSTRONG Regenerative Circuit

Sales Agents for
**MARLE AUDIO
FREQUENCY
TRANSFORMERS**

*used exclusively
on all De Forest
equipment*

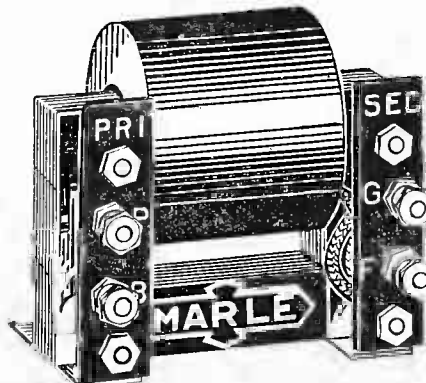

Distributors for
BRANDES

Superior
"Matched Tone"
Phones

Stock These Profitable Items

North Ward Jacks (all sizes); Little Wizard Detectors
Sockets, single, double and triple

Wire, Phone or Write for Prices and Discounts

NORTH WARD RADIO CO., 72 Orange St., Newark, N. J.

"FERRIDAN" CONDENSERS

Do not tend to PRY
THEMSELVES APART.

Their insulation will not
become distorted in DAMP
OR HOT WEATHER.

They do not require
counterweights, as the same
results are obtained by our
special design, which does
not range, *by increasing
their minimum value.*

Though they are *praised
highly—their price is low.*

They are manufactured
by—

THE FERRIDAN RADIO EQUIPMENT CO.

245-247 Centre St.

New York City, N. Y.

Telephone Canal 5277

MERCURY RADIO PRODUCTS CO.

We manufacture
a full line
of Quality
Products.

Loose Couplers
Crystal Sets
Bulb Sets

Write for Details

51 Thomas St.
ORANGE, N. J.

NEW MODELS ON WAY

The engineers of the Rosemark Radio Corporation, of New York, are now working night and day completing several new models to be included in their regular line. These models will be known as the Type E and F, and the Rose-Radiola Grand, which will compete favorably with the period-designed cabinets which are now entering the market at from four to five hundred dollars.

The instrument is mounted complete in a phonograph-type cabinet which holds batteries, control and panels, loud speaker. When the instrument is closed there is nothing about it to suggest radio, and yet it is readily opened to permit immediate adjustment.

This machine is not yet ready to be placed on the market, but a sample has been made up with three stages of amplification which has surprised even the constructors of the model with its tone quality and finished appearance. The price of this set has not yet been announced, but it is understood that this unit will be popularly priced and undersell other period cabinet sets now on the market. Watch Rosemark's advertisement in the September issue for the formal announcement of this unit.

"FARADION" CONDENSERS

The Radio Laboratories of New Jersey, Inc., have developed a line of fine variable condensers. These condensers are designed by J. B. Elenschneider, formerly engineer for the Marconi Wireless Telegraph Company of America. They are made of the best material and with excellent workmanship. The plates are punched from hard aluminum of heavy gauge, and are shaped so as to give a "straight line" wave length curve and the lowest possible capacity when the condenser is set at minimum. The ends are of "Fieldite," one of the best dielectrics known and are guaranteed not to change their shape under any condition. All other parts are of turned brass, finely finished and nickel plated. The Rotor shaft is turned from 5/8-inch hard drawn brass rod with both ends running in bronze bearings.

The condensers are made for panel mounting and have a 1/4-inch shaft extension for a knob or dial. Soft rubber stops are provided to insure noiseless operation.

The condensers are fully guaranteed, and each instrument is carefully inspected and tested.

MORSEOPHONE

*Radio Instruments of
Excellence*

Crystal and Two Stage Amplifying—Bakelite Panel, mahogany finish and heavy nickel platings. Write for our descriptive literature and discounts. Reliable sales representatives wanted.

Instrument Only, \$22.50 List
Instrument Complete, \$30.00 List

Wm. H. Downs Radio Co.
86 Park Place Newark, N. J.

FIRST NATIONAL CONVENTION RADIO CHAMBER OF COMMERCE

July 26, 27, 28, 29, at
Washington, D. C.

Full Details Will Appear in AUGUST
ISSUE of

MASONIC REVIEW
of New York, N. Y.

Which has been designated as the
OFFICIAL ORGAN

Of the Convention Activities

It will also contain the Addresses by world renowned Radio Experts, and the Advertisements of largest Radio Manufacturers, Jobbers and Distributors. If you want your Advertisement to appear in this Convention Issue, here is Your Opportunity. Send it in *at once*—with cuts—will quote price on receipt of advertisement. We go to press by August 12th, latest.

Address, MASONIC REVIEW
Radio Manager
8 Reade St., New York

GUARANTEED
QUALITY radio supplies at LOW PRICES
and PROFIT allowing
discounts.

Variometers \$3.75 up
Vario Couplers 2.50 "
Vario Condensers 2.00 "
B Batteries 1.75 "

*Wire, Parts and Supplies
Special Purchasing Service*

McConnell Cable &
Specialty Co.

426 1/2 S. Clinton St., Chicago, Ill.

JOY-KELSEY CORPORATION

Manufacturers
RADIO EQUIPMENT
4021 West Kinzie St. Chicago Ill.

Armstrong Pointers

A Few Things Every Dealer in Radio Should Know

By S. E. TUPPER, M. E.
Of Astorloid Mfg. Co.

Dealers should familiarize themselves with the Armstrong super-regenerative circuit because the fans are greatly interested in this circuit and secondly because some knowledge about the Armstrong circuit will make for proper selling of essential parts—and that's what retailers ought to be interested in. (THE RADIO DEALER Service Bureau is at your command for information desired). Here are a few facts about the Armstrong circuit:

The UV-200 tube cannot be used on the Armstrong super-regenerative set. The UV-201 can be used provided reduction is made in the plate voltage and not over 60 volts are employed on any of the plate circuits.

Honeycomb coils can be used on the Armstrong circuit, provided the total inductance equals that of the open core choke coil of ten milli-henries induction.

The ordinary 3,000 ohm phones

should not be used because the amount of current flowing through the coils will be too large for them. Phone suggestion to "fans": A telephone receiver of the type using a mica diaphragm actuated by a balance armature.

Oxide filament .201 volt tubes may be used—provided these are "hard" tubes.

An audio-frequency transformer is used before the third tube, which is the regular amplifier tube, similar to the one-step amplifier. Any standard will be O. K. with Armstrong.

Ordinary vari-coupler can be used for the tuning circuit and tickler coil. It probably will be necessary for the "fan" to double the number of turns on the rotor when using the standard vario-coupler.

A 6-volt battery can be used as an "A" battery, which will be common for all three tubes, and "B" batteries are used on the plate circuit of all three tubes, with 90 volts on the first two tubes and 200 volts on the third.

There is no ground connection, since the loop aerial is used with the Armstrong set—but you can experiment.

Other parts necessary are: Variable condenser .001 mfd. capacity; "C" Battery, 4 volts; resistances, 12,000 ohms each; fixed condenser, .005 mfd.; "B" Battery,

80 volts; variable condenser, .0005 mfd.; 2 coil adjustable mounting; duo-lateral coil, 1,500; duo-lateral coil, 1,250; 6 volt storage battery, and rheostat.

SMALL TUBE SET

One of the smallest and most compact tube sets on the market is being manufactured by the Melchior Equipment Co. This set is made to meet the demand for a popular priced set that will meet the demands of the not so rich radio fan.

This set is well made and is sold complete with a pair of phones. It is very simple to operate and requires very little adjusting and is specially adaptable for the man that is looking for a set that requires very little up-keep cost.

Mr. P. Melchior, the head of this concern promises an innovation to the trade when he will offer this set to the trade "knocked down." This innovation will specially appeal to the man who likes to tinker with his set, and then boast of the fact that he made his own set.

Territory is being allotted to distributors in various parts of the country, and the Melchior Equipment Company will only sell through these distributors.

DEPENDABLE RADIO INSULATION

EMPIRE OILED TUBING

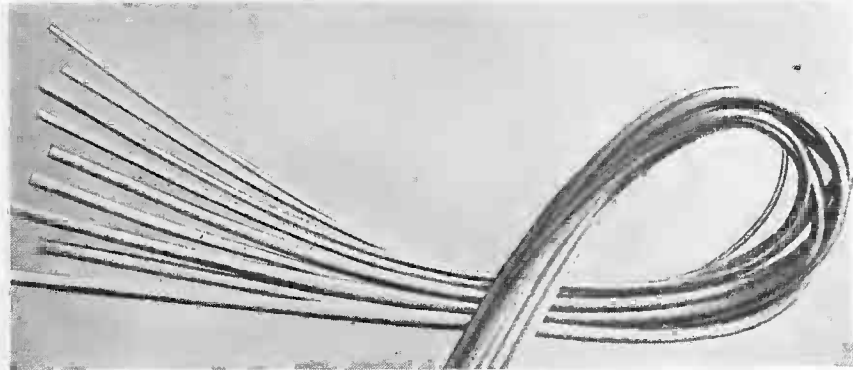

Much superior to ordinary "spaghetti" because it has been made for years to meet the electrical industry's most exacting requirements. Provides maximum insulating and dielectric strength; is flexible, smooth and strong. It maintains your reputation for handling quality radio equipment. All radio sizes, in various colors, and standard 36 inch lengths.

MICANITE TUBES

Places at the disposal of every radio amateur an insulation product famous for 30 years. For coil winding it renders the utmost in service. In all radio sizes and various lengths to 36 inches.

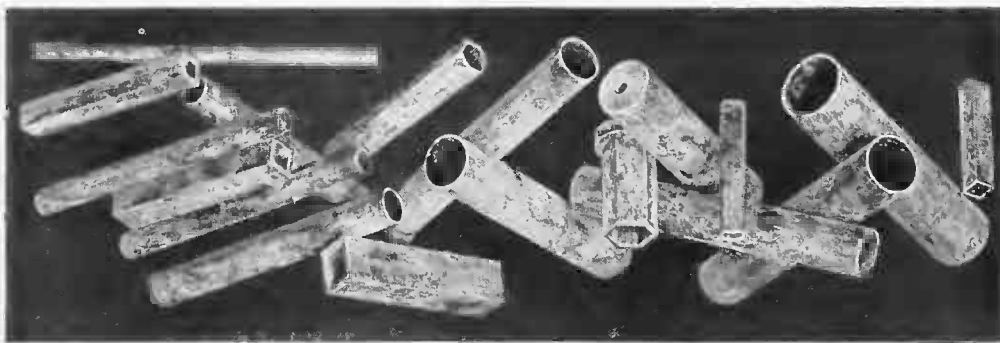

Our products keep customers coming for more. Send for samples and literature

MICA INSULATOR COMPANY

68 Church Street, New York. 542 So. Dearborn Street, Chicago. Works: Schenectady, N. Y.

Cincinnati Agent: MONROE BRASS & WIRE CO. Cleveland Agent: G. ARTHUR MORRELL
San Francisco and Los Angeles Agent: ELECTRICAL SPECIALTY CO.

Where to Buy

A Handy Guide for the Convenience of Our Readers

AERIAL RACONY PLUG	
Radio Company of New York.....	102
H. Ploug.....	86
AERIALS	
Walter S. Krenz.....	89
ARMSTRONG HOOK-UP	
The Radio Guild.....	9
AMPLIFIERS	
Horning Experimental Laboratories.	81
F. C. Kent Co.....	42
Sheltone Radio Sales Co.....	90
ANTENNA LIGHT WIRE PLUGS	
American Electro Phone Co.....	88
C. Bisgard & Co.....	92
Condenser Specialty Co.....	62
ANTENNA WIRE	
Hintze Bros., Inc.....	69
Copper Clad Steel Co.....	48
BAKELITE PANELS	
Standard Radio Parts Co.....	71
Federal Radio & Electric Co.....	67
BATTERIES	
Novo Manufacturing Co.....	63
Standard Electric Novelty Co.....	89
French Battery & Carbon Co.....	64
Enco Electric Novelty Co.....	85
U. S. Storage Battery Co.....	48
Mauhattau Storage Battery Co.....	58
Comet Battery Co.....	48
Economic Appliance Co.....	69
Carbon Products Co.....	37
"BESTONE" PARTS	
Henry Hyman & Co., Inc.....	75
BINDING POSTS	
John Cozzone Co.....	91
The H.H. Eby Mfg. Co.....	45
Royal Eastern Elect. Supply Co.....	54
Premier Radio Mfg. Co.....	47
Radio Accessories Co.....	83
BOOKS	
Allied Engineering Institute.....	7
Normand W. Henley Pub. Co.....	68
John Firth Co.....	42
Radio Courses, Inc.....	53
BOXES	
Weis Mfg. Co.....	52
BRASS PARTS	
McKenna Brass and Mfg. Co.....	50
BUSINESS OPPORTUNITIES	
A. J. Winters.....	62
CABINETS	
Eshoo Cabinet Works.....	67
CABINET SETS	
Premier Radio Corp.....	14
Pittsburgh Radio Supply Co.....	77

COMPLETE LINE	
American Radio & Electric Co.....	38
Clapp Eastham Co.....	35
Chelton Electric Co.....	5
Freed-Eisemann Radio Corp.....	78
A. C. Gilbert Co.....	18
Radio & Mechanical Trading Corp..	85
Mercury Radio Products Co.....	98
COMPOSITION	
Scheuroth Letonite Co.....	89
CONDENSERS	
Seaboard Radio Corp.....	51
Chelsea Radio Co.....	4
Reuedon Radio Equipment Co.....	98
Duke Radio Co.....	64
European Radio Company.....	57
Bunting Stamp Co.....	50
Scheib Elec. Radio Co.....	60
Robbins Electric Co.....	47
Meirowsky.....	65
United Mfg. & Dist. Co.....	76
Tonks Mfg. Co.....	67
CONDENSER PARTS	
New Haven Radio Co.....	68
CONTRACT WORK	
Carlyle Johnson Machine Co.....	52
COUPLERS	
Capitol Phonolier Co..Inside back cover	
Moreland Sales Corp.....	46
CRYSTALS	
Dugdale Laboratories.....	88
Harris Laboratory.....	64
U. S. Radio Co. of Penna., Inc.....	48
Rocky Mountain Radio Products, Inc.	54
CRYSTAL DETECTORS	
Randel Wireless Co.....	61
North Ward Radio Equip. Co.....	70
Volta Engineering Co.....	64
Diamant Tool and Mfg. Co., Inc..	88
CRYSTAL SETS	
Detroit Radio Co.....	88
DIALS	
The Emeloid Co., Inc.....	63
New York Radio Dial Co.....	88
Box 104.....	46
DIAL SWITCHES	
Virginia Radio Corp.....	83
DISTRIBUTORS	
Alladena Radio Laboratories.....	87
Beacon Radio & Elect. Co.....	58
Harold M. Schwab, Inc.....	20
Detroit Electric Company.....	48
P. D. Jackson.....	52
Federal Radio & Elect. Co.....	67
Radio Equipment Co.....	52
Wholesale Radio Equipment Co.....	
Front Cover	
Moss Radio Co.....	50
Radio Equipment Service.....	15
Nyco.....	81
General Radio Laboratories, Inc..	33
City Supply Co.....	53
Elco Radio Supply Co.....	50

Mydar Radio Co.....	6
Radio Stores Corporation.....	102
Radio & Mechanical Trading Corp..	85
Kramer Radio Co.....	78
Pittsburg Radio Supply House.....	43
White Radio Co.....	46
Metropolitan Radio Corp.....	45
Radio Electric Co.....	3
Pittsburg Radio & Appliance Co...	58
Specialty Service Co.....	66
North Ward Radio Co.....	70
Virginia Radio Corp.....	83
ELECTROTYPERS	
Central Electrotyping Company....	58
ENGINEERING & TESTING SERVICE	
Gregg and Co.....	10
GLASS	
Vineland Scientific Glass Co.....	48
GRID LEAKS	
Radiophone Equipment Co.....	58
Whitehouse Radio & Mfg. Co.....	46
HEAD SETS	
Federal Telephone & Telegraph Co..	4
North Ward Radio Co.....	70
Rex Radio Sales Co.....	76
Premier Accessory & Specialty Co...	13
Telephone Book Holder Corp.....	50
INFORMATION	
Service Bureau.....	8
Mica Insulator Co.....	99
INSULATION	
National Fibre & Insulation Co.....	5
INSULATORS	
Morscan Radio Company...Back cover	
JOBBERS WANTED	
Ajax Radio Corp.....	44
Sound Wave Corporation.....	83
Wireless Phone Corp.....	88
KNOBS	
Champlin Mfg. Co.....	72
KNOCK DOWN PANEL UNITS	
Simplex Radio Co.....	65
LIGHTNING ARRESTERS	
L. S. Brach Mfg. Co.....	58
Electric Service Supplies Co.....	6
LOOP AERIALS	
Eagle Radio Co.....	90
LOUD SPEAKERS	
The Magnavox Co.....	39
LOUD SPEAKER SETS	
General Auto Electric Company....	44
MAGNET WIRE	
Richmond Elec. Co.....	49
MAILING LISTS	
Ross-Gould Co.....	50
Sydell's Radio Directory & Service..	61
Chicago Trade Addressing Co.....	88
MANUFACTURERS' REPRESENTATIVES	
Radio Equipment Service.....	52
P. D. Jackson.....	92

Where to Buy

A Handy Guide For the Convenience of Our Readers

METALS	
Strahs Aluminum Co.....	52
Steel Sales Corporation.....	46
MICA	
Mica Insulator Co.....	101
MULTILISTENER	
F. C. Manning Co.....	75
NAME PLATES	
Name Plate Co.....	44
PANEL WINDOWS	
Stevens.....	72
PANELS	
The Continental Fibre Company.....	51
Miho Company.....	60
Standard Wireless Panel Co.....	57
Beau Ivorie Co.....	92
PAPER TUBES	
Baehm Paper Co.....	52
PART MAKERS	
Steel Products Mfg. Co.....	44
Merit Machine Mfg. Co.....	50
Raymond Radio Corporation, Inside Front Cover	
Specialty Service Co.....	81
Wilcox Laboratories.....	66
PARTS	
Metropolitan Radio Corp.....	45
PATENTS	
Otto K. Zvingenberger.....	52
Manufacturers Patent Co.....	52
PHONES	
Alcemo Mfg. Co.....	94
Herbert H. Frost.....	58
Globe Phone Mfg. Co.....	47
General Radio Equipment Mfg. Co.....	9
Newark Engineering & Tool Co.....	54
Rex Radio Sales Co.....	76
Standard Electric Sales Co.....	10
Stevenson Bros. Sales & Eng. Co.....	71
Sterling Devices Co.....	87
Tower Mfg. Co.....	72
True-Tone Radio Mfg. Co.....	86
PLUGS	
The Wolbrack Co., , , Inside Front Cover	
S. S. Novelty Co.....	86
POTENTIOMETERS	
W. J. Millard & Co.....	94
PRECISION INSTRUMENTS	
Interstate Radio Corp.....	53
PUBLICATIONS	
Radio Dealer Weekly.....	95
Radio Dealer, The.....	54
Masonic Review.....	98
Radio Telegrapher.....	20
Radio Red Book Pub. Co.....	78
RADIO CRYSTAL ATTACHMENT	
Rad'O.....	55

RADACK EQUIPMENT	
Clapp-Eastham Co.....	35
RADIOLITE	
Radio Equipment Service.....	16, 17
RECEIVING SETS	
Apex Radio Service.....	91
Aerex Radiophone Corp.....	62
Aronex Radio Sales Co.....	83
Corona Electric Corp.....	96
W. R. Cramer Co.....	52
W. H. Downs Co.....	98
Mercury Radio Products Co.....	98
Montclair Radio Corp.....	37
Specialty Service Co.....	81
Pittsburgh Radio Supply House.....	77
Rosemark Radio Corp.....	80
Steinmetz Wireless Mfg. Co.....	62
States Radio Corp.....	96
Tresco Radio Co.....	88
Paul G. Niehoff Co.....	44
L. P. Horning, Jr.....	69
Interstate Radio Co.....	53
Joy Kelsey Corp.....	98
M. P. Radio Co.....	60
P. E. Edelman.....	54
Volta Engineering Co.....	64
Lewis and De Roy Co.....	79
Rogers Radio Co.....	66
Melchior Equipment Co.....	73
Radio Outfitting Co.....	78
E. M. Wilson & Co.....	51
RHEOSTATS	
A. H. Redden.....	66
Keystone Radio Co.....	49
ROTARY SWITCHES	
Storm-Lee Radio Apparatus Co.....	91
SALESMEN WANTED	
Royal Electrical Laboratories.....	92
SCREW MACHINE PRODUCTS	
Merit Machine Mfg. Co.....	50
SELLING ORGANIZATIONS	
James R. Sheedy.....	48
SHEET COPPER	
McKenna Brass & Mfg. Co.....	50
SIGNS	
Merchants' Sign Service.....	44
SOLDERING IRONS (ELECTRIC)	
North Shore Radio Works.....	58
SPAGHETTI TUBING	
Mitchell Rand Mfg. Co.....	52
Mills Radio & Electric Co.....	50
Jewell Radio Co.....	50
Mica Insulator Co.....	99
STOCK BROKERS	
Frank T. Stanton & Co.....	54
SWITCHES	
Ford Mica Co., Inc.....	63
SWITCH STOPS	
Mydar Radio Co.....	6
Premier Radio Mfg. Co.....	47

TESTING LABORATORIES	
N. Y. Testing Laboratories.....	52
THREE COIL MOUNTINGS	
Astorloid Mfg. Co.....	38
York Radio Co.....	78
TRADE MARKS	
Chauncey P. Carter.....	57
Radio Dealer Trade Mark Bureau..	60
TRANSFORMERS	
Thornton Transformer Co.....	54
Atwater-Kent Mfg. Co.....	59
E. M. Wilson & Son.....	51
TUNER AND DETECTOR UNITS	
Aronax Radio Sales Co.....	83
Montclair Radio Mfg. Corp.....	99
TUNING COILS	
National Radio Co.....	42
UNIT TYPE SETS	
Jewett Mfg. Co.....	41
Tresco Mfg. Co.....	88
VACUUM TUBE SOCKETS	
Keystone Radio Co.....	49
VARIABLE CONDENSERS	
Duquesne Radio & Mfg. Co.....	64
Montrose Mfg. Co.....	42
Jesser Radio Sales Co.....	96
New Haven Radio Co.....	68
United Mfg. & Distributing Co.....	76
Radio Laboratory of N. J.....	13
White Radio Co.....	92
VARIO CONDENSERS	
David Rosen.....	58
VARIO-COUPERS	
Maclite Radio Co.....	96
Marvin B. Fallgatter.....	62
Magnetic Mfg. Co.....	78
VARIOMETERS	
Eastern Specialty Co.....	73
Franklin Radio Mfg. Co.....	46
McConnell Cable and Specialty Co.	98
Nelson Radio Parts Co.....	12
Sound Wave Corp.....	83
VARIOMETERS AND PARTS	
Scientific Dealers' Supply Co.....	88
VERNIER CONDENSERS	
J. E. Jenkins, Not Inc.....	52
VEST POCKET SETS	
Boldo Radio & Electric Co.....	48
WIRE	
McConnell Cable & Specialty Co.....	98
WOOD PARTS	
R. C. Mills.....	64
WINDING	
Montclair Radio Co.....	62

Says the Customer:—

"I want a variable condenser for the set I'm building. What do you recommend?" And you say—"A receiving set is no better than its variable condenser, and you should operate the best. Buy a

**RADIO
STORES
CORP.**
RE

RADIO STORES VARIABLE CONDENSER

It has these advantages—

Counter weight under dial. Brass studs through aluminum plates and die cast. Shaft held in true center through brass bushings. Binding posts mounted on metal straps. No insulating material tapped—metal inserts throughout. Precision workmanship and best engineering design.

It is made in two sizes, 23 Plate .0005 mfd. capacity and 43 Plate .001 mfd. capacity.

"I would also recommend—



**THE RADIO STORES
TORPEDO PLUG.
IT'S UNBREAKABLE**

All conductive parts are of heavy machined brass, insulated throughout. It has screw binding post terminals, with separate anchor for tail of cord, and is designed to insure rigidity, durability, strength and lightness.

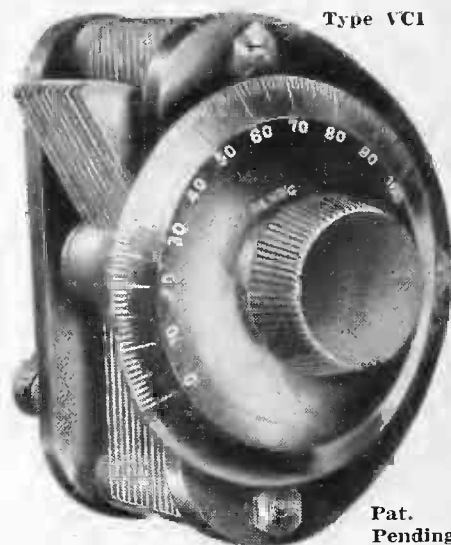

**222
West
34th St.
New York City**

**DEALERS: Write for prices and proposition
Address Department D**

*E
l
e
c
t
r
i
c

S
o
c
k
e
t

A
t
t
a
c
h
m
e
n
t

P
l
u
g
s*

The ONLY Adjustable Plug on the Market

RACONY PLUG

\$3.00 and well worth it

Attach to Any
Electric Light Socket

Consumes No
Current

Made to
Stand 2500 Volts

Genuine Mica
Dielectric

This is the ONLY 4 Outlet Plug and has 14 Combinations



With the Racony plug you can give your customers the BEST on the market and make a handsome PROFIT for yourself.

THE RACONY CORP.
SUCCESSORS TO
The Radio Co. of N. Y.
799 Broadway, New York City

No More Aerial or Outside Wires

*M
a
d
e

t
o

S
t
a
n
d

2
5
0
0

V
o
l
t
s*

The New "ALL WAVE"

COMBINATION FLAT AND BANK-WOUND

Coupler

LIST PRICE \$9

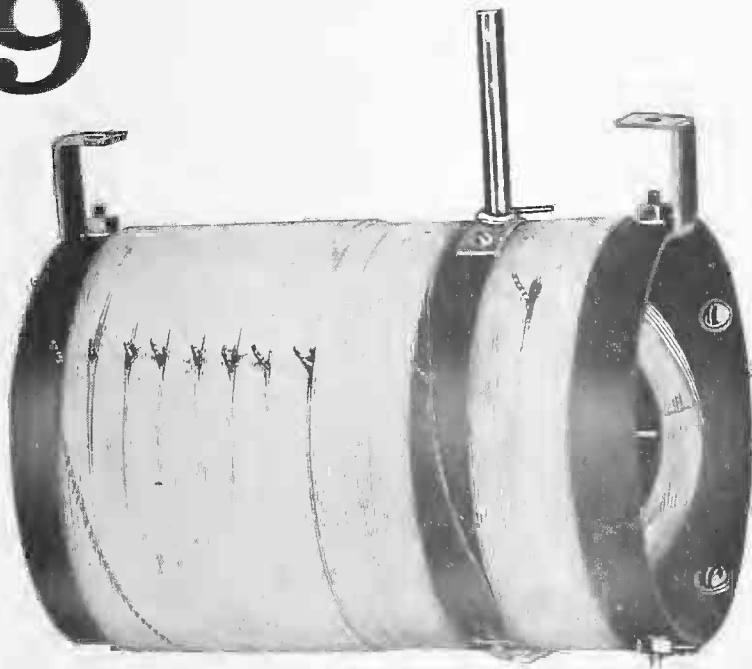

PATENT PENDING

Guaranteed Wave Length, 150 to 3000 Meters

Eliminates the use of:

All Variometers

Variocouplers

and Loading Coils

Permits the building of the most compact and efficient Receiver at a considerably lower cost.

We guarantee each "ALL WAVE" Coupler (with money-back guarantee) to give maximum results for long or short-wave, long-distance *selective reception*.

Important Notice! We are the originators of the "ALL WAVE" Coupler (patents applied for in U. S. and all foreign countries). Any attempts at infringement of our patent rights will be promptly dealt with. We also warn dealers and jobbers to beware of imitators of our product.

Distributors, write or wire for rights in your territory

Manufactured by

Capitol Phonolier Corporation

54-60 Lafayette Street

NEW YORK, N. Y.

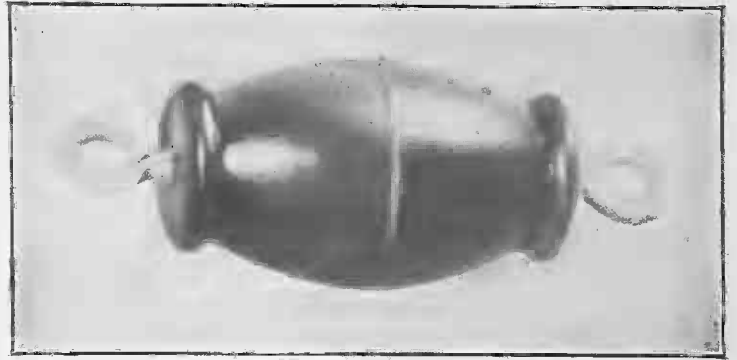
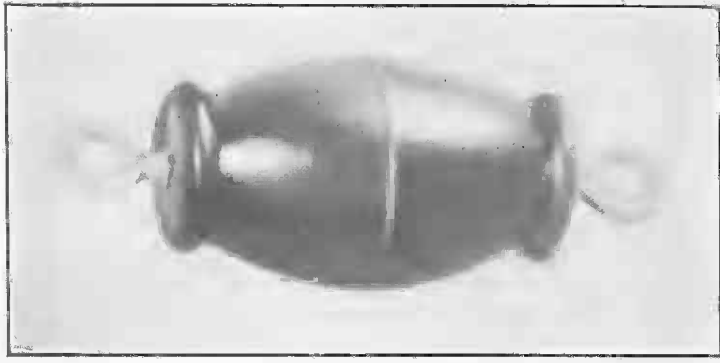

When You Need Insulators

PHONE, WIRE OR WRITE

For Sample and Prices

TERRITORY OPEN TO
RELIABLE JOBBERS

Our Prices are Right

MORSCAN RADIO CO.

196 MARKET STREET

NEWARK, N. J.

